

# Basic Drapes & Accessories



Advanced Protection System  
**Innovation Focus: Barrier Performance**

V6.4



At Multigate we combine our deep understanding of how you work with our design capabilities to innovate and better serve you, your patients and our partners.

For 30 years we've created medical products, services and experiences that give you the advantage to perform at your best. We continue to do this.

Inspiring performances and better patient outcomes that will lead the world of hospital care to new standards.

We are Multigate.



## ADVANCED PROTECTION SYSTEM

We have combined over fifteen years of experience in drape development for the Australian perioperative market, with state of the art materials and manufacturing technologies, to bring you the latest in imperviousness and absorbency, delivering unbeatable patient and surgical team protection.

- ✓ Impervious
- ✓ High absorption capacity and speed
- ✓ Soft and pliable
- ✓ Strong and durable
- ✓ Low linting
- ✓ No latex



Improved microbial barrier performance



Excellent draping capability

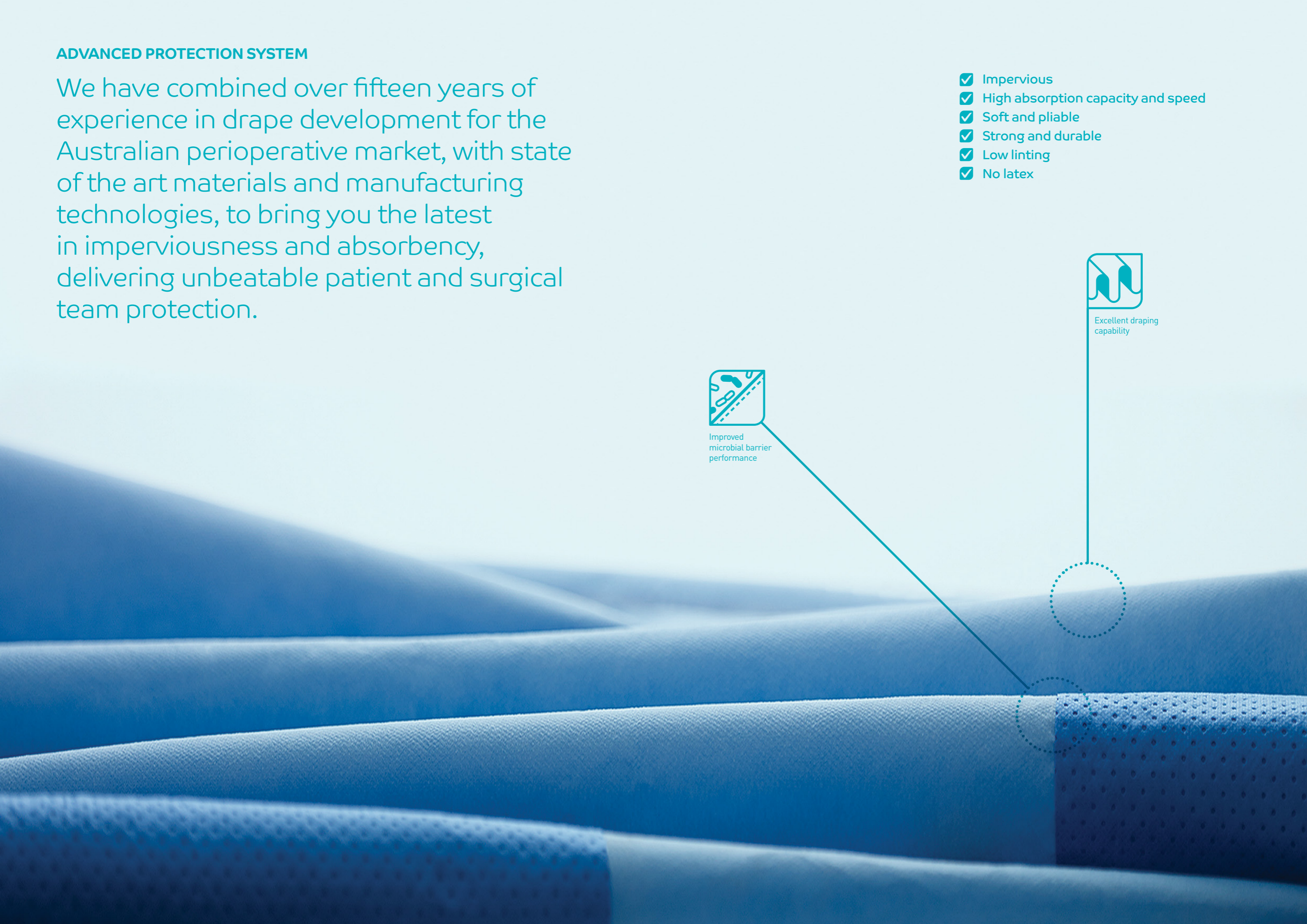

## TECHNOLOGY — STATE OF THE ART MATERIALS TECHNOLOGY

Multigate Protex<sup>®</sup>4 Drapes utilise a pliable, yet tough impervious bi-laminate technology, supported by an additional generous ultra-reinforcement layer. They are designed to deliver maximum absorbency and strikethrough prevention and eliminate bacterial transfer.

## FEATURES — SUPERIOR BARRIER PERFORMANCE

Superior Barrier Performance  
Multigate Protex<sup>®</sup>4 drapes deliver impervious AAMI level 4 protection not just in the critical zone but across the entire drape.

### High performance tethers.

Our tethers provide a strong heavy duty hold to manage quivers and leads with confidence.

### Reliable adhesion.

Protex<sup>®</sup>4 drapes offer a reliable incise film and adhesion performance and are suitable for all skin types.

### Fluid collection.

Fluid pouches made from polyethylene offer a durable heavy duty seal and are combined with strategically placed suction ports to aid the capture, monitoring and management of fluid and blood loss.

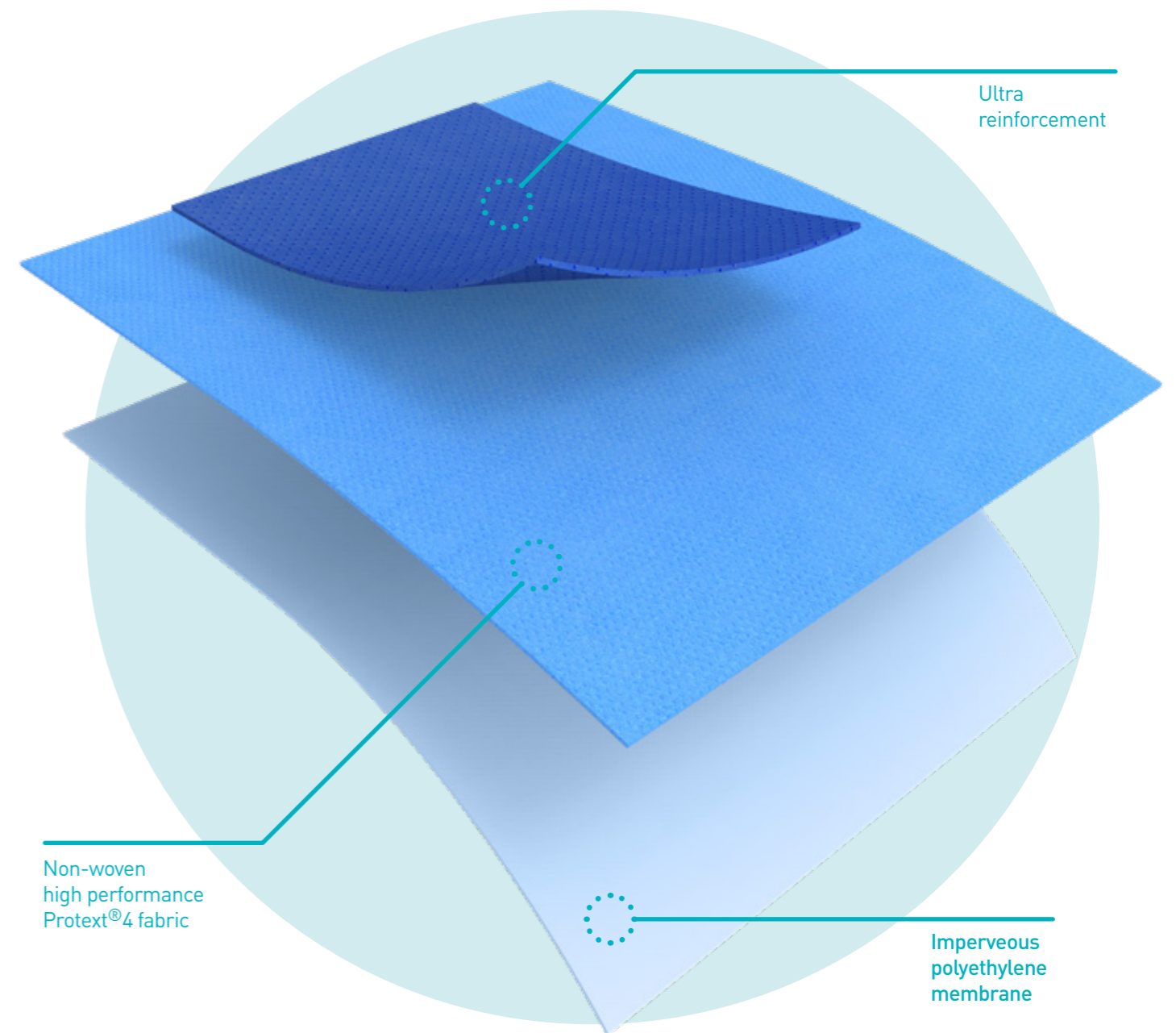

# Basic Drapes & Accessories

## CONTENTS

Plastic Drapes	9
Protex® Drapes	11
Drape Sheets without Adhesive	13
Drape Sheets with Adhesive	17
Universal Drapes	20
Universal Drape Sets	22
Aperture Drapes	23
Aperture Drapes without Adhesive	23
Aperture Drapes with Adhesive	26
Aperture Drapes with Reinforcement and Adhesive	33
Split Drapes	36
Split Drape Sets	37
Back Table Covers	38
Mayo Covers	40
Stockinette and Leggings	43
Drape Accessories	44
Fluid Pouches	46
Probe Covers	48
II Covers	49
Leadscreens Covers	51

PRODUCT MATERIAL KEY:



Plastic Drapes	RE-ORDER	DESCRIPTION	CARTON QTY	NON STERILE
	22-200	Plastic Drape • Drape 60cm x 45cm	100	DP 1095



Plastic Drapes	RE-ORDER	DESCRIPTION	CARTON QTY	NON STERILE
	22-201	Plastic Drape • Drape 91cm x 61cm	100	DP 1087

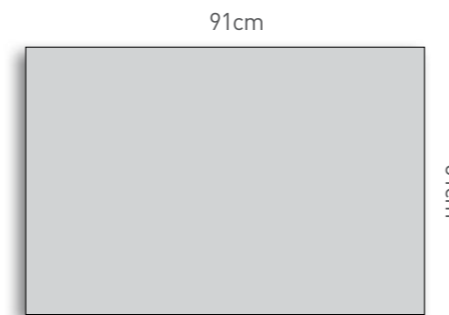

Plastic Drapes	RE-ORDER	DESCRIPTION	CARTON QTY	NON STERILE
	22-202	Plastic Drape • Drape 152cm x 76cm	100	DP 1088

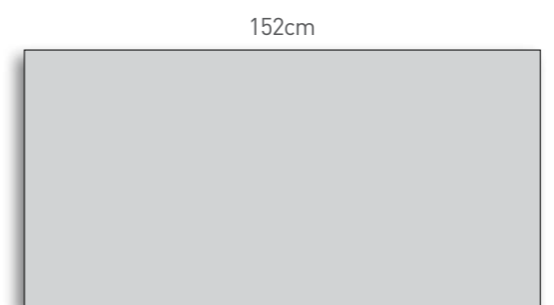

 Protex® Drapes have an absorbent top layer with an impervious backing.

PRODUCT MATERIAL KEY:



Plastic Drapes

RE-ORDER	DESCRIPTION	CARTON QTY	NON STERILE
22-203	Plastic Drape • Drape 120cm x 90cm	100	DP 1093

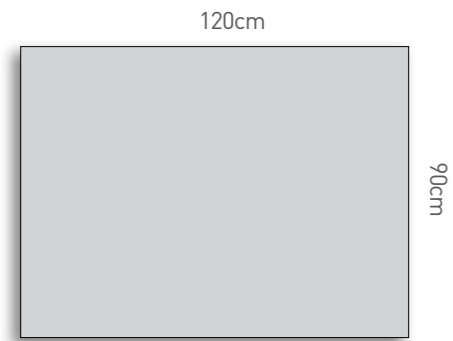

Plastic Drapes

RE-ORDER	DESCRIPTION	CARTON QTY	NON STERILE
22-205	Plastic Drape • Drape 140cm x 120cm	100	DP 1094

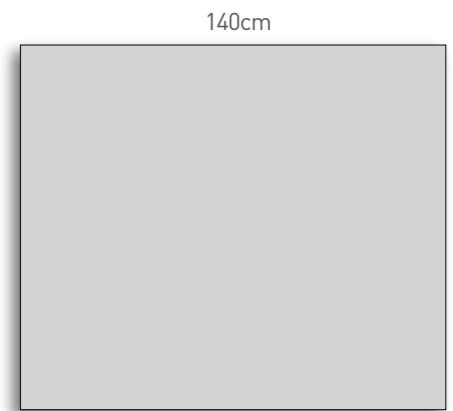

Protex Drapes

RE-ORDER	DESCRIPTION	CARTON QTY	NON STERILE
29-900	Protex Drape • Drape 60cm x 60cm	100	DP 1530

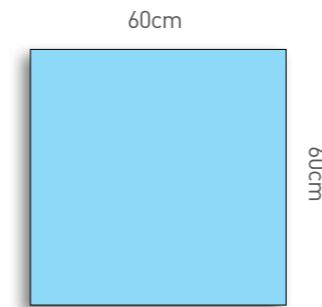

Protex Drapes

RE-ORDER	DESCRIPTION	CARTON QTY	NON STERILE
29-902	Protex Drape • Drape 90cm x 90cm	100	DP 1680

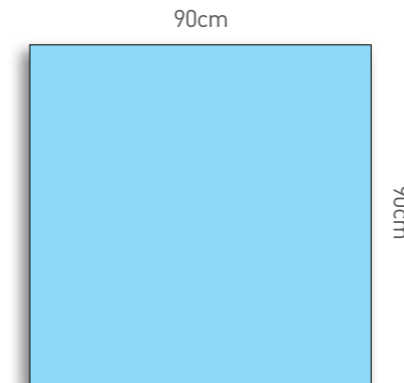

Protex Drapes

RE-ORDER	DESCRIPTION	CARTON QTY	NON STERILE
29-903	Protex Drape • Drape 90cm x 120cm	60	DP 1586

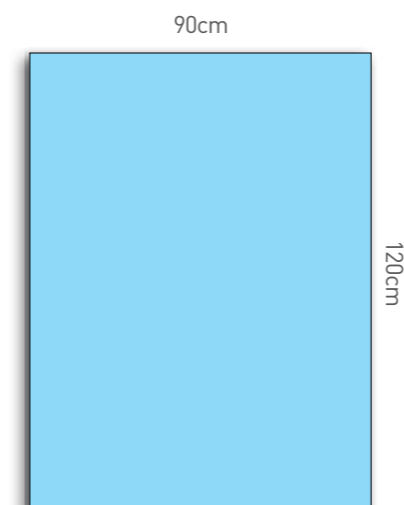

 Protex® Drapes have an absorbent top layer with an impervious backing.

PRODUCT MATERIAL KEY:



**Protex Drapes**

RE-ORDER	DESCRIPTION	CARTON QTY	NON STERILE
29-924	<b>Protex Drape</b> • Drape 120cm x 120cm	90	DP 1681

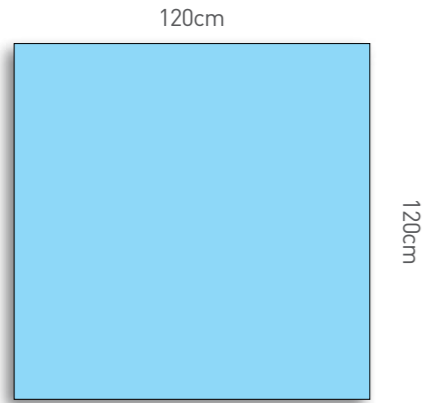

**Drape Sheets without Adhesive**

RE-ORDER	DESCRIPTION	CARTON QTY	NON STERILE
29-220	<b>Fluid Impervious Drape</b> • Drape 60cm x 60cm	100	29-220/S

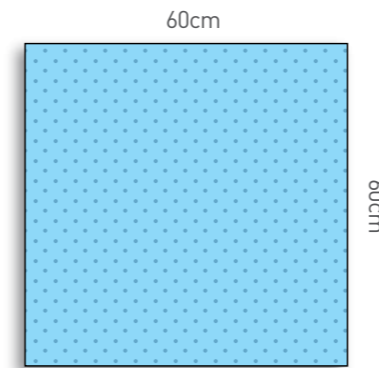

**Protex Drapes**

RE-ORDER	DESCRIPTION	CARTON QTY	NON STERILE
29-905	<b>Protex Drape</b> • Drape 120cm x 140cm	60	DP 1647

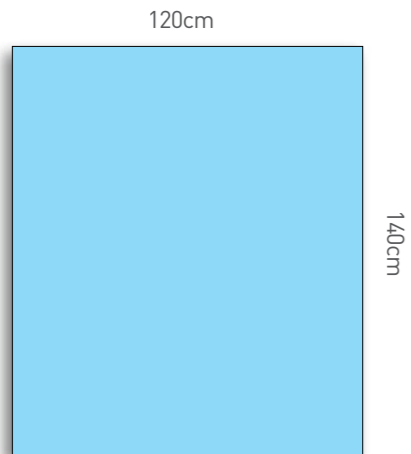

**Drape Sheets without Adhesive**

RE-ORDER	DESCRIPTION	CARTON QTY	NON STERILE
29-223	<b>Fluid Impervious Drape</b> • Drape 90cm x 90cm	100	DP 1409

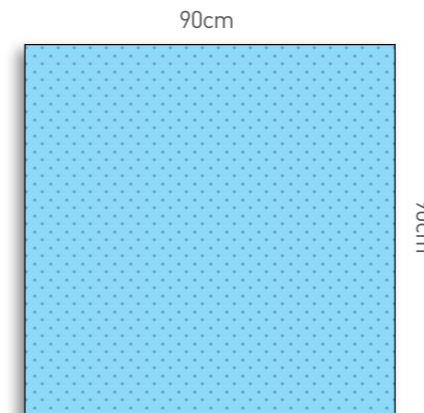

**Drape Sheets without Adhesive**

RE-ORDER	DESCRIPTION	CARTON QTY	NON STERILE
29-225	<b>Fluid Impervious Drape (Twin Pack)</b> • Drape 90cm x 90cm	50	DP 1410

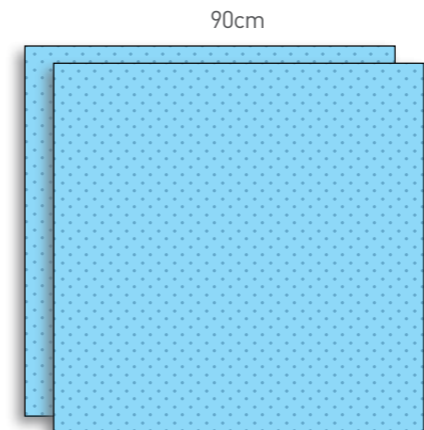

 Protex® Drapes have an absorbent top layer with an impervious backing.

PRODUCT MATERIAL KEY:



Drape Sheets without Adhesive

RE-ORDER	DESCRIPTION	CARTON QTY	NON STERILE
35-152	<b>Utility Drape</b> • Drape 70cm x 60cm	70	35-152NS

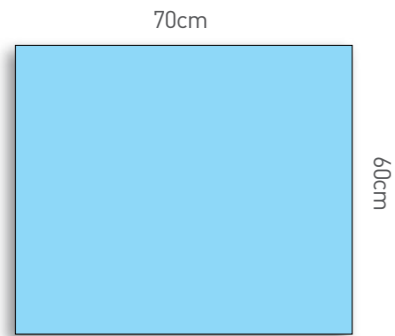

Drape Sheets without Adhesive

RE-ORDER	DESCRIPTION	CARTON QTY	NON STERILE
35-070	<b>Absorbent 3/4 Drape Sheet</b> • Drape 150cm x 180cm • Ultra reinforcement 75cm x 120cm	20	35-070NS

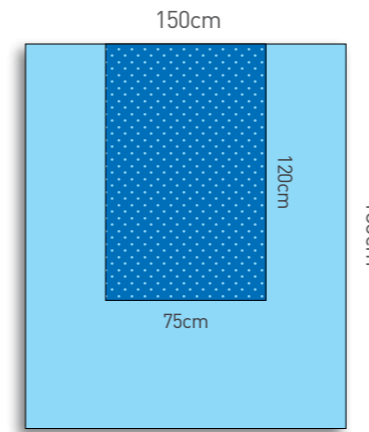

Drape Sheets without Adhesive

RE-ORDER	DESCRIPTION	CARTON QTY	NON STERILE
35-057	<b>Utility Drape</b> • Drape 100cm x 100cm	30	35-057NS

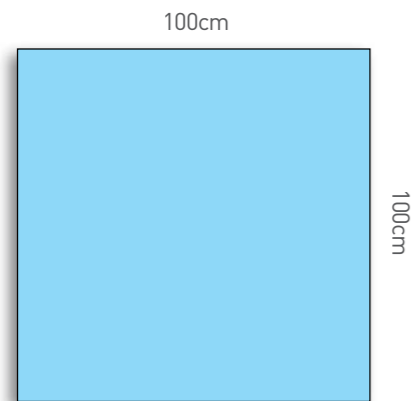

Drape Sheets without Adhesive

RE-ORDER	DESCRIPTION	CARTON QTY	NON STERILE
28-114	<b>Trauma Sheet</b> • Drape 80cm x 150cm • Absorbent	25	ST 0089

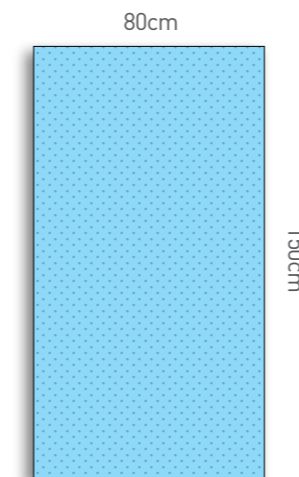

Drape Sheets without Adhesive

RE-ORDER	DESCRIPTION	CARTON QTY	NON STERILE
35-127	<b>Utility Drape</b> • Drape 150cm x 112cm	50	35-127NS

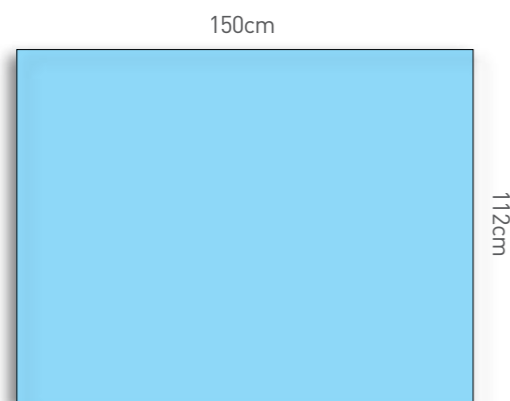

Drape Sheets without Adhesive

RE-ORDER	DESCRIPTION	CARTON QTY	NON STERILE
35-032	<b>Drape Sheet</b> • Drape 200cm x 110cm	30	35-032NS

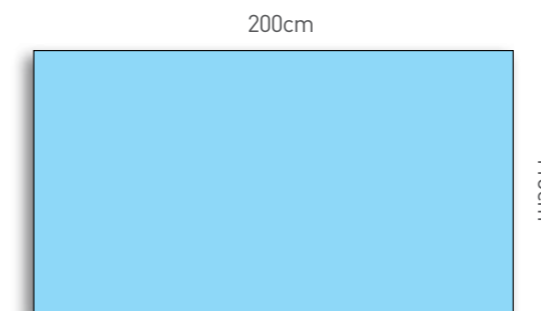



 Protex® Drapes have an absorbent top layer with an impervious backing.

PRODUCT MATERIAL KEY:



Drape Sheets without Adhesive

RE-ORDER	DESCRIPTION	CARTON QTY	NON STERILE
35-071	<b>Drape Sheet</b> • Drape 150cm x 200cm	10	35-071NS

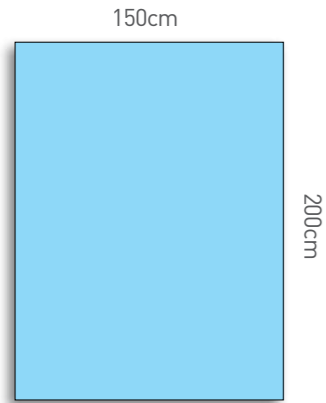

Drape Sheets with Adhesive

RE-ORDER	DESCRIPTION	CARTON QTY	NON STERILE
28-111	<b>Absorbent Pad Drape with Tape</b> • Drape 70cm x 50cm • Adhesive 70cm x 5cm • Absorbent Drape	35	ST 0039

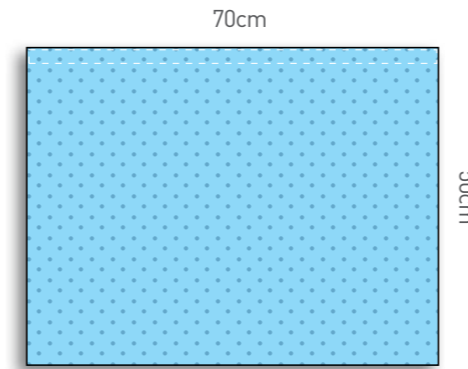

Drape Sheets without Adhesive

RE-ORDER	DESCRIPTION	CARTON QTY	NON STERILE
35-001	<b>Absorbent Large Drape</b> • Drape 200cm x 200cm	6	35-001NS

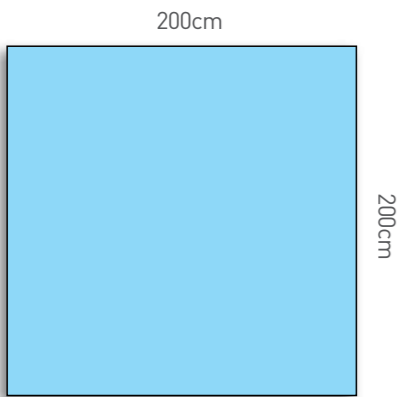

Drape Sheets with Adhesive

RE-ORDER	DESCRIPTION	CARTON QTY	NON STERILE
35-169	<b>Adhesive Drape</b> • Drape 65cm x 37cm with adhesive	70	35-169NS

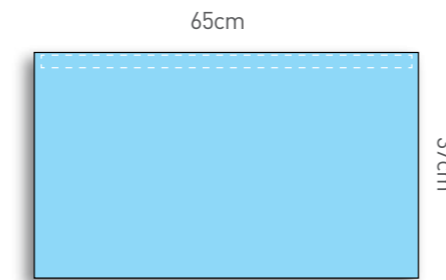

Drape Sheets with Adhesive

RE-ORDER	DESCRIPTION	CARTON QTY	NON STERILE
35-153	<b>Adhesive Drape</b> • Drape 70cm x 60cm with adhesive	50	35-153NS

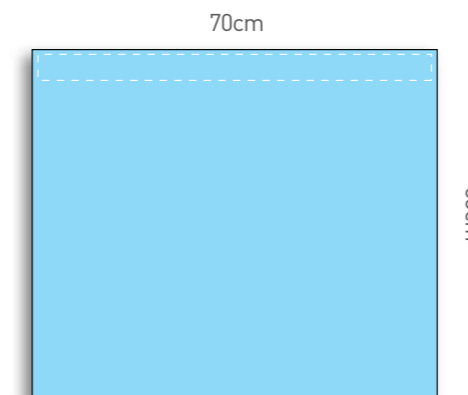

 Protex® Drapes have an absorbent top layer with an impervious backing.

PRODUCT MATERIAL KEY:



**Drape Sheets with Adhesive**

RE-ORDER	DESCRIPTION	CARTON QTY	NON STERILE
35-136	<b>Adhesive Drape</b> • Drape 100cm x 75cm with adhesive	50	35-136NS

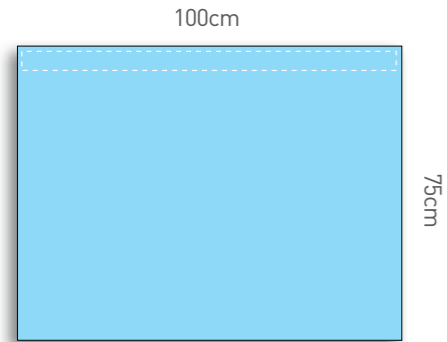

**Drape Sheets with Adhesive**

RE-ORDER	DESCRIPTION	CARTON QTY	NON STERILE
35-102	<b>Adhesive Drape</b> • Drape 180cm x 180cm • Adhesive 120cm x 4.5cm	30	35-102NS

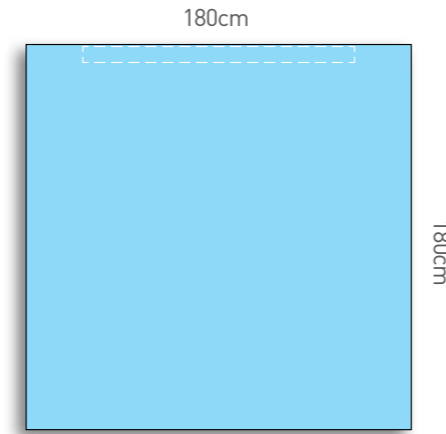

**Drape Sheets with Adhesive**

RE-ORDER	DESCRIPTION	CARTON QTY	NON STERILE
35-101	<b>Adhesive Drape</b> • Drape 100cm x 90cm with adhesive	76	35-101NS

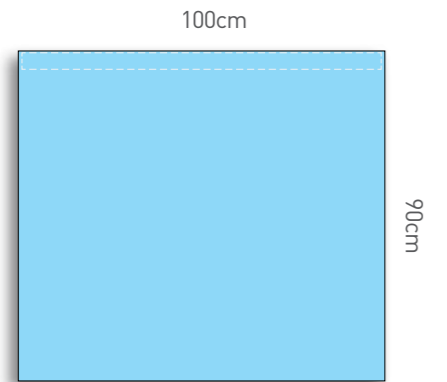

**Drape Sheets with Adhesive**

RE-ORDER	DESCRIPTION	CARTON QTY	NON STERILE
35-116	<b>Large Long Drape with Adhesive</b> • Drape 260cm x 150cm • Adhesive 166cm x 4.5cm	40	35-116NS

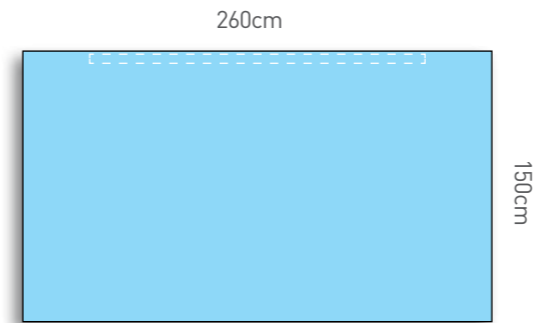

**Drape Sheets with Adhesive**

RE-ORDER	DESCRIPTION	CARTON QTY	NON STERILE
35-115	<b>Small Body Drape with Adhesive</b> • Drape 150cm x 100cm with adhesive	50	35-115NS

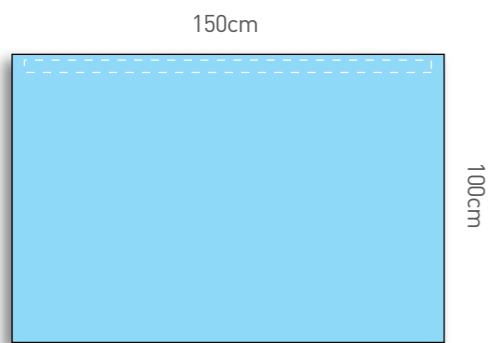

 Protex® Drapes have an absorbent top layer with an impervious backing.

PRODUCT MATERIAL KEY:



Universal Drapes

RE-ORDER	DESCRIPTION	CARTON QTY	NON STERILE
----------	-------------	------------	-------------

35-029	<b>Universal Top Drape with Armboard Cover</b>	20	35-029NS
--------	--	----	----------

• Drape 260cm x 150cm  
 • Ultra reinforcement 60cm x 30cm  
 • Adhesive 64cm x 5cm  
 • Tube holder/fastener

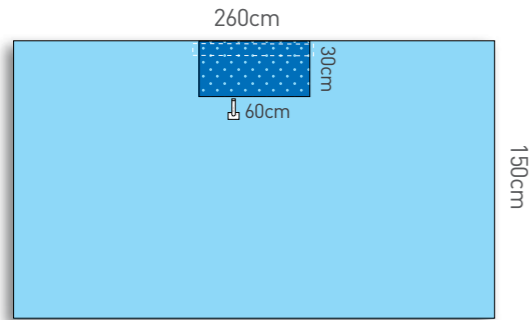

Universal Drapes

RE-ORDER	DESCRIPTION	CARTON QTY	NON STERILE
----------	-------------	------------	-------------

35-031	<b>Universal Side Drape - Long</b>	20	35-031NS
--------	------------------------------------	----	----------

• Drape 200cm x 115cm  
 • Ultra reinforcement 110cm x 40cm  
 • Adhesive 200cm x 5cm

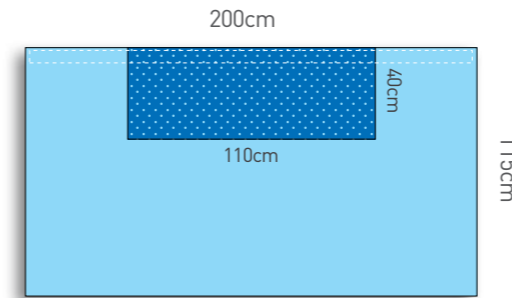

Universal Drapes

RE-ORDER	DESCRIPTION	CARTON QTY	NON STERILE
----------	-------------	------------	-------------

35-030	<b>Universal Bottom Drape</b>	20	35-030NS
--------	-------------------------------	----	----------

• Drape 180cm x 180cm  
 • Ultra reinforcement 60cm x 37.5cm  
 • Adhesive 64cm x 5cm  
 • Tube holder/fastener

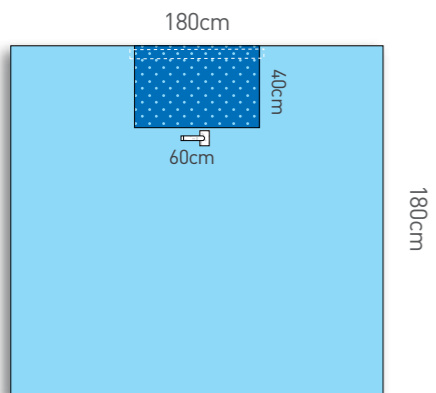

Universal Drapes

RE-ORDER	DESCRIPTION	CARTON QTY	NON STERILE
----------	-------------	------------	-------------

35-163	<b>Universal Side Drape with Fabric Pouch</b>	40	35-163NS
--------	---	----	----------

• Drape 210cm x 100cm  
 • Adhesive 210cm x 10cm  
 • Ultra reinforcement 160cm x 35cm with pouch (160cm x 20cm)  
 • Tube holders/fasteners

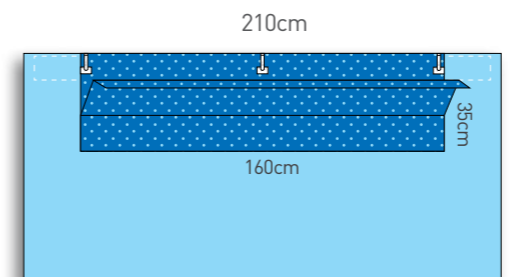

Universal Drapes

RE-ORDER	DESCRIPTION	CARTON QTY	NON STERILE
----------	-------------	------------	-------------

35-028	<b>Universal Side Drape - Short</b>	40	35-028NS
--------	-------------------------------------	----	----------

• Drape 115cm x 90cm  
 • Ultra reinforcement 60cm x 40cm  
 • Adhesive 114cm x 5cm  
 • Tube holder/fastener

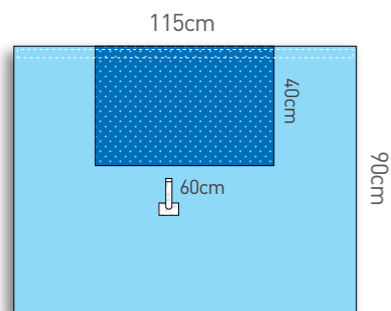

 Protex® Drapes have an absorbent top layer with an impervious backing.

PRODUCT MATERIAL KEY:



Universal Drape Sets

RE-ORDER	DESCRIPTION	CARTON QTY	NON STERILE
<b>35-176</b>	<b>Universal Drape Set - Short Sides without Mayo Cover</b>	5	
A.	1 x Back Table cover (Medium) 140cm x 230cm	PE 0003/B	
B.	2 x Universal side drapes (Short) 115cm x 90cm	35-028NS	
C.	1 x Universal bottom drape 180cm x 180cm	35-030NS	
D.	1 x Universal top drape with armboard cover 260cm x 150cm	35-029NS	

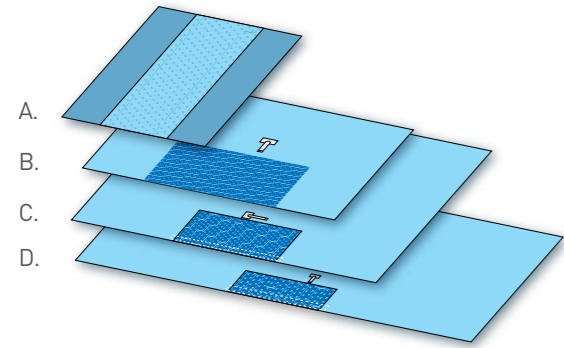

Universal Drape Sets

RE-ORDER	DESCRIPTION	CARTON QTY	NON STERILE
<b>35-022A</b>	<b>Universal Drape Set - Short Sides with Ultra Mayo Cover</b>	5	
A.	1 x Suture bag with tape 39cm x 29cm	DP 3000	
B.	1 x Back table cover (Medium) 137cm x 230cm	PE 0003/B	
C.	1 x Ultra Mayo cover 60cm x 137cm	35-006NS	
D.	2 x Universal side drapes (Short) 115cm x 90cm	35-028NS	
E.	1 x Universal bottom drape 180cm x 180cm	35-030NS	
F.	1 x Universal top drape with armboard cover 260cm x 150cm	35-029NS	

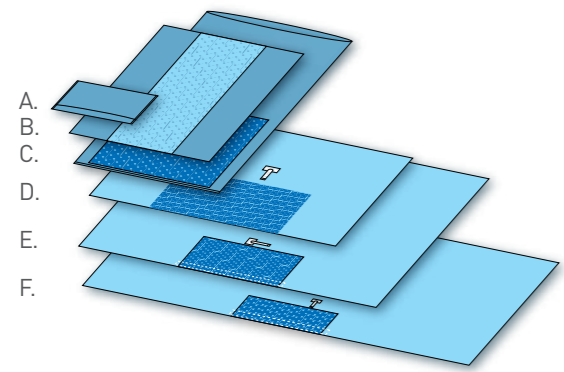

Universal Drape Sets

RE-ORDER	DESCRIPTION	CARTON QTY	NON STERILE
<b>35-021</b>	<b>Universal Drape Set - Long Sides with Ultra Mayo Cover</b>	12	
A.	1 x Back table cover (Medium) 137cm x 230cm	PE 0003/B	
B.	1 x Ultra Mayo cover 60cm x 137cm	35-006NS	
C.	2 x Universal side drapes (Long) 200cm x 115cm	35-031NS	
D.	1 x Universal bottom drape 180cm x 180cm	35-030NS	
E.	1 x Universal top drape with armboard cover 260cm x 150cm	35-029NS	

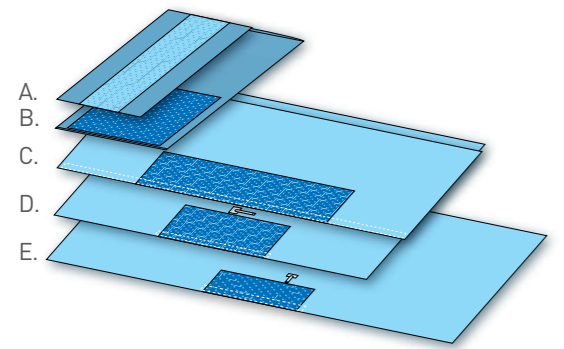

Aperture Drapes without Adhesive

RE-ORDER	DESCRIPTION	CARTON QTY	NON STERILE
<b>29-612</b>	<b>Impervious Drape with Oval Aperture</b>	120	N/A
	• Drape 45cm x 60cm		
	• Oval aperture 7.5cm x 6cm		

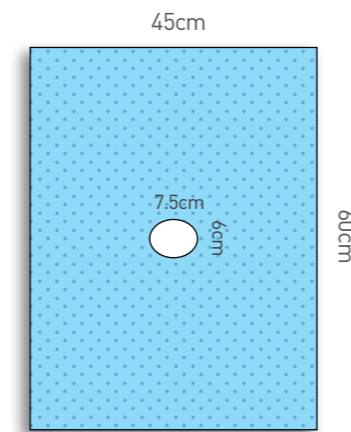

Aperture Drapes without Adhesive

RE-ORDER	DESCRIPTION	CARTON QTY	NON STERILE
<b>29-614</b>	<b>Impervious Drape with Oval Aperture</b>	120	N/A
	• Drape 75cm x 45cm		
	• Oval aperture 7.5cm x 6cm		

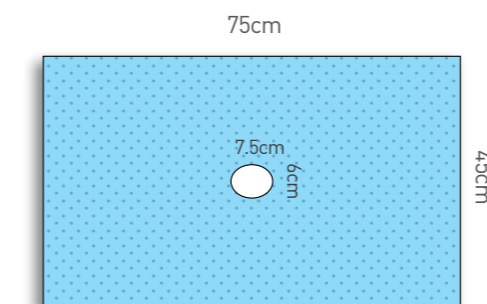

Aperture Drapes without Adhesive

RE-ORDER	DESCRIPTION	CARTON QTY	NON STERILE
<b>29-620</b>	<b>Impervious Drape with Oval Aperture</b>	100	N/A
	• Drape 60cm x 60cm		
	• Oval aperture 7.5cm x 6cm		

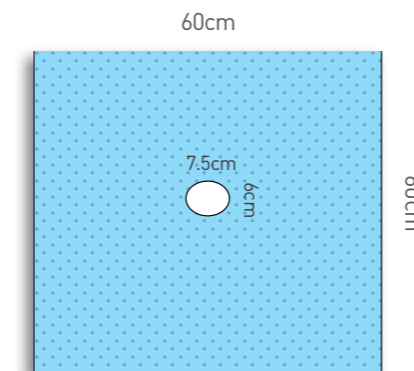

 Protex® Drapes have an absorbent top layer with an impervious backing.

PRODUCT MATERIAL KEY:



Aperture Drapes without Adhesive

RE-ORDER	DESCRIPTION	CARTON QTY	NON STERILE
29-634	<b>Impervious Drape with Oval Aperture</b> • Drape 90cm x 90cm • Oval aperture 7.5cm x 6cm	100	N/A

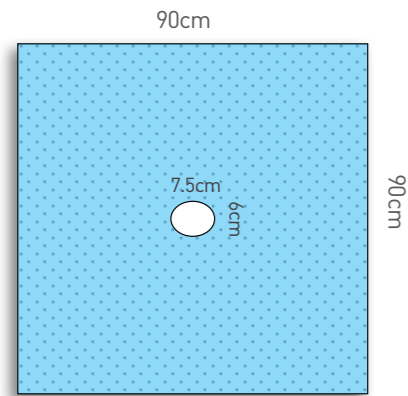

Aperture Drapes without Adhesive

RE-ORDER	DESCRIPTION	CARTON QTY	NON STERILE
35-187	<b>Impervious Drape with Round Aperture</b> • Drape 100cm x 120cm • Round aperture 12cm diameter	60	35-187NS

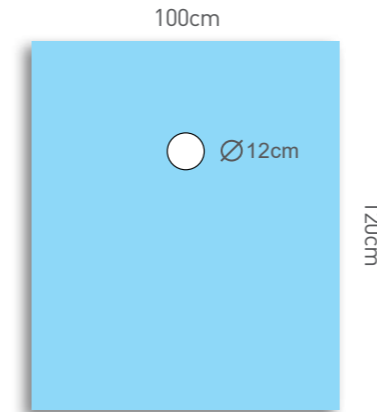

Aperture Drapes without Adhesive

RE-ORDER	DESCRIPTION	CARTON QTY	NON STERILE
28-352	<b>Fluid Resistant Small Drape with Rectangle Aperture</b> • Drape 85cm x 100cm • Rectangle aperture 9cm x 18cm	40	ST 0084

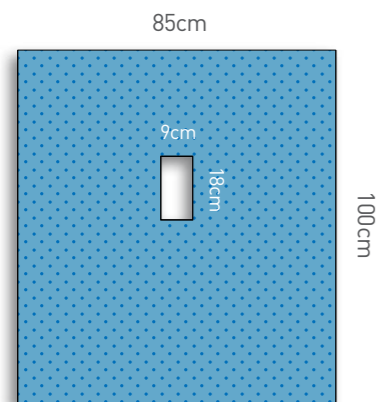

Aperture Drapes without Adhesive

RE-ORDER	DESCRIPTION	CARTON QTY	NON STERILE
35-183	<b>Impervious Drape with Oval Aperture</b> • Drape 120cm x 150cm • Oval aperture 6cm x 8cm	50	35-183NS

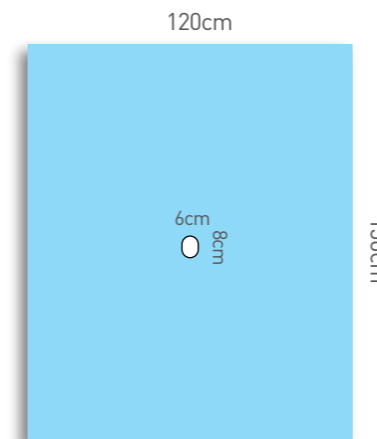

Aperture Drapes without Adhesive

RE-ORDER	DESCRIPTION	CARTON QTY	NON STERILE
35-061	<b>Impervious Central Line Insertion Kit</b> • Drape 100cm x 90cm • Round aperture 6cm diameter • Clear PE 20cm x 90cm  <b>Kit includes</b> • Central line Drape • Plain drape 40cm x 50cm • Instrument table cover 112cm x 140cm	40	35-061NS

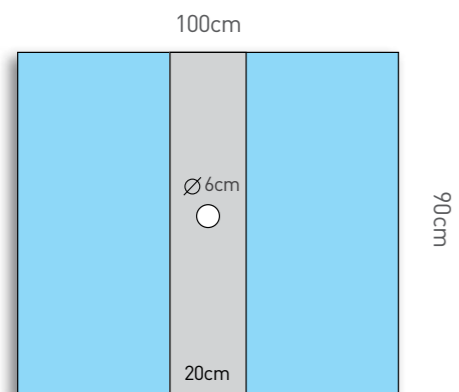

Aperture Drapes without Adhesive

RE-ORDER	DESCRIPTION	CARTON QTY	NON STERILE
35-184	<b>Impervious Drape with Aperture</b> • Drape 150cm x 120cm • Rectangular aperture 15cm x 24cm	40	35-184NS

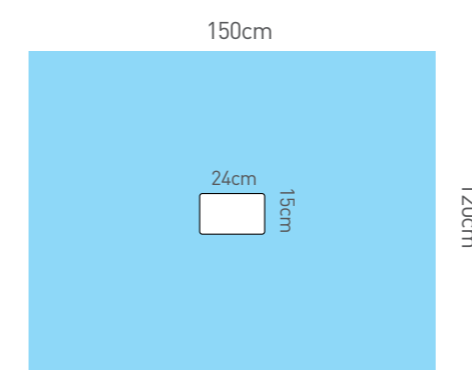

 Protex® Drapes have an absorbent top layer with an impervious backing.

PRODUCT MATERIAL KEY:



Aperture Drapes with Adhesive

RE-ORDER	DESCRIPTION	CARTON QTY	NON STERILE
29-780	<b>Impervious Drape with Adhesive Oval Aperture</b> • Drape 60cm x 60cm • Adhesive oval aperture 7.5cm x 6cm • Adhesive corners	100	DP 1302

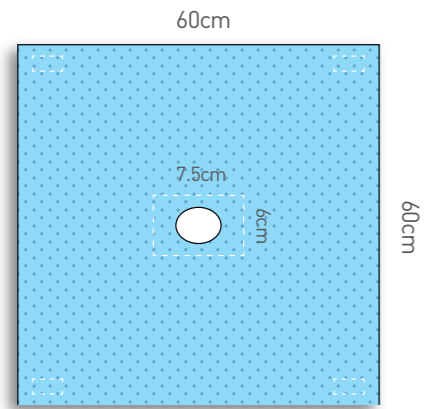

Aperture Drapes with Adhesive

RE-ORDER	DESCRIPTION	CARTON QTY	NON STERILE
35-065	<b>Impervious Drape with Adhesive Oval Aperture + Split</b> • Drape 75cm x 75cm • Adhesive oval aperture 8cm x 6cm • Adhesive corner tabs • Tear line for easy drape removal	50	35-065NS

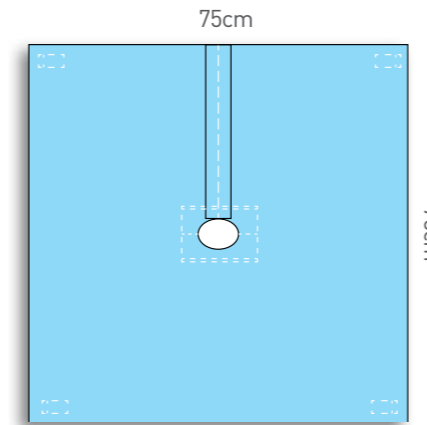

Aperture Drapes with Adhesive

RE-ORDER	DESCRIPTION	CARTON QTY	NON STERILE
35-134	<b>Impervious Drape with Adhesive Oval Aperture</b> • Drape 60cm x 60cm • Adhesive oval aperture 8cm x 6cm • Adhesive corners	100	35-134NS

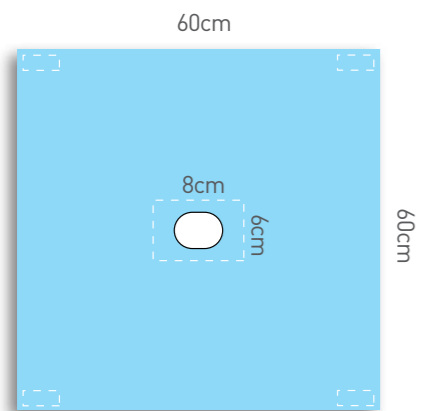

Aperture Drapes with Adhesive

RE-ORDER	DESCRIPTION	CARTON QTY	NON STERILE
35-133	<b>Impervious Drape with Adhesive Aperture</b> • Drape 60cm x 60cm • Adhesive aperture 15cm x 10cm	50	35-133NS

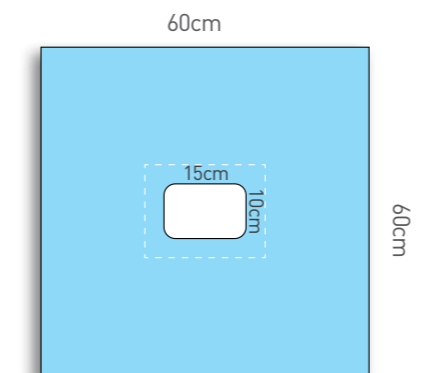

Aperture Drapes with Adhesive

RE-ORDER	DESCRIPTION	CARTON QTY	NON STERILE
29-788	<b>Impervious Drape with Adhesive Oval Aperture</b> • Drape 75cm x 75cm • Adhesive oval aperture 7.5cm x 6cm • Adhesive corners	100	DP 1295

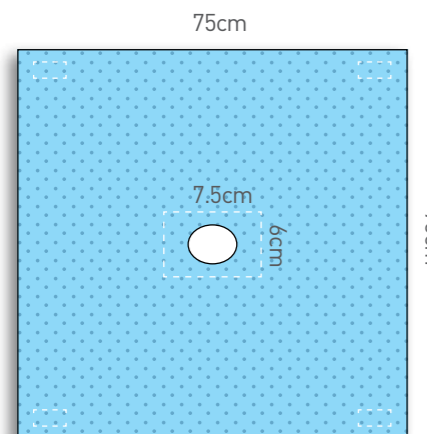

Aperture Drapes with Adhesive

RE-ORDER	DESCRIPTION	CARTON QTY	NON STERILE
29-794	<b>Impervious Drape with Adhesive Oval Aperture</b> • Drape 90cm x 90cm • Adhesive oval aperture 7.5cm x 6cm • Adhesive corners	100	29-794NS

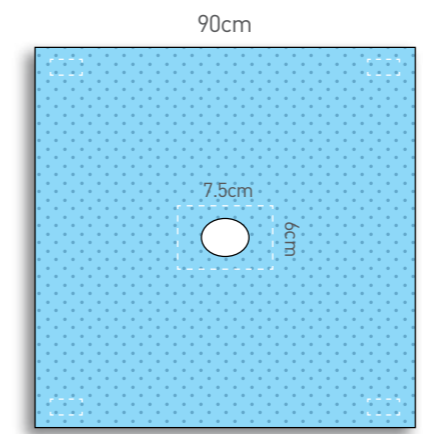

 Protex® Drapes have an absorbent top layer with an impervious backing.

PRODUCT MATERIAL KEY:



Aperture Drapes with Adhesive

RE-ORDER	DESCRIPTION	CARTON QTY	NON STERILE
35-165	<b>Epidural Drape</b>	50	35-165NS

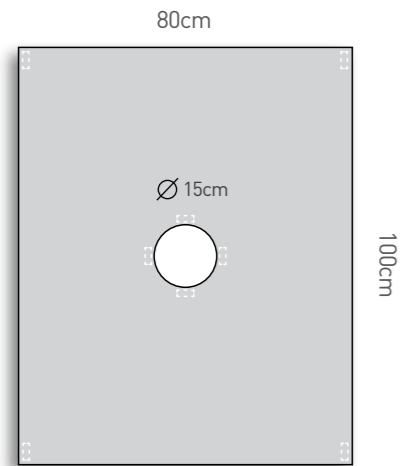

- Drape 80cm x 100cm
- Round aperture 15cm diameter with adhesive tabs
- Clear PE material
- Adhesive corner tabs

Aperture Drapes with Adhesive

RE-ORDER	DESCRIPTION	CARTON QTY	NON STERILE
35-145	<b>Spinal Drape with Adhesive Aperture</b>	50	35-145NS

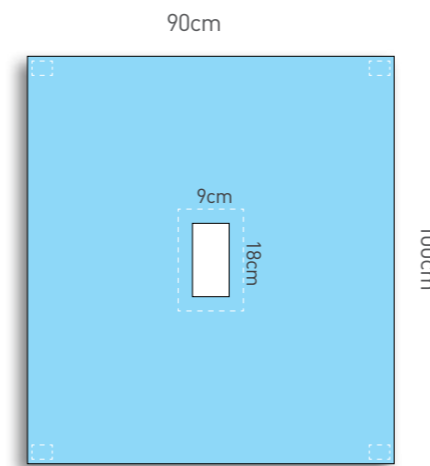

- Drape 90cm x 100cm
- Adhesive rectangle aperture 9cm x 18cm
- Adhesive corner tabs

Aperture Drapes with Adhesive

RE-ORDER	DESCRIPTION	CARTON QTY	NON STERILE
35-100	<b>Impervious Epidural Drape with Adhesive Round Aperture</b>	50	35-100NS

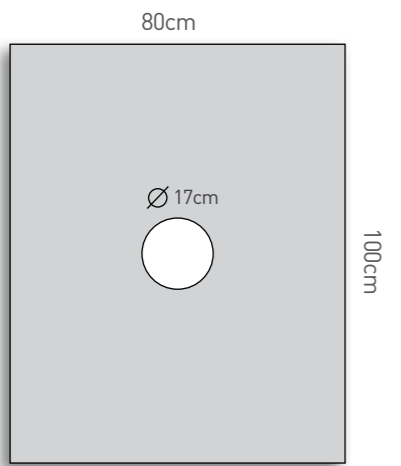

- Drape 80cm x 100cm
- Round aperture 17cm diameter with adhesive tabs
- Clear PE material
- Adhesive corner tabs

Aperture Drapes with Adhesive

RE-ORDER	DESCRIPTION	CARTON QTY	NON STERILE
35-141	<b>Epidural Drape Clear with Adhesive Aperture</b>	40	35-141NS

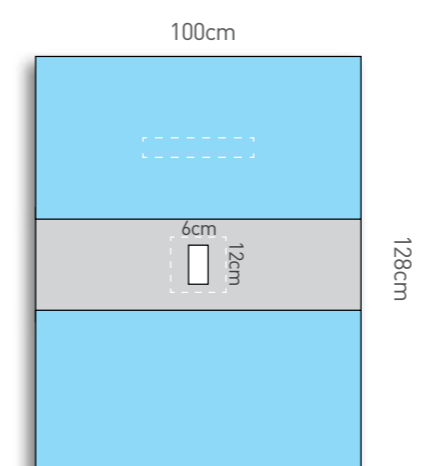

- Drape 100cm x 128cm
- Adhesive rectangular aperture 6cm x 12cm
- Adhesive positioning tape
- Clear PE 100cm x 28cm

Aperture Drapes with Adhesive

RE-ORDER	DESCRIPTION	CARTON QTY	NON STERILE
29-942	<b>Plastic Drape with Fenestration</b>	100	DP 1577

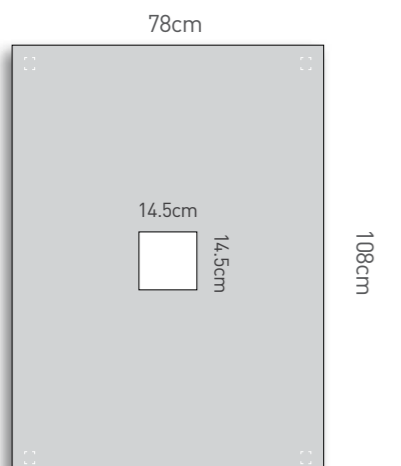

- Drape 78cm x 108cm
- Fenestration 14.5cm x 14.5cm
- Adhesive corner tabs

Aperture Drapes with Adhesive

RE-ORDER	DESCRIPTION	CARTON QTY	NON STERILE
35-026	<b>Impervious Epidural Drape with Adhesive Rectangle Aperture</b>	20	35-026NS

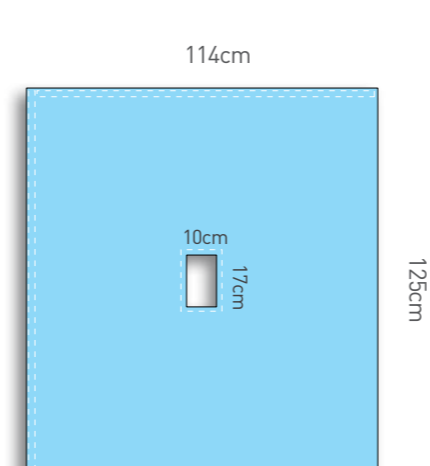

- Drape 114cm x 125cm
- Adhesive rectangle aperture 10cm x 17cm
- Adhesive securing tapes

 Protex® Drapes have an absorbent top layer with an impervious backing.

PRODUCT MATERIAL KEY:



Aperture Drapes with Adhesive

RE-ORDER	DESCRIPTION	CARTON QTY	NON STERILE
22-213	<b>Epidural Drape Clear PE</b>	100	DP 1752

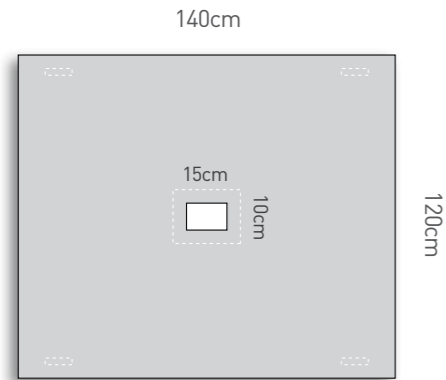

- Drape 140cm x 120cm
- Adhesive aperture 15cm x 10cm
- Clear PE material

Aperture Drapes with Adhesive

RE-ORDER	DESCRIPTION	CARTON QTY	NON STERILE
35-106	<b>Impervious Drape with Adhesive Rectangle Aperture</b>	60	35-106NS

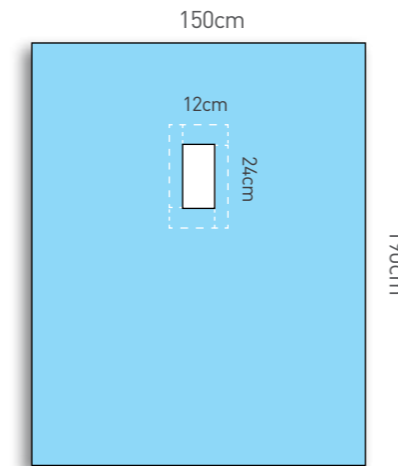

- Drape 150cm x 190cm
- Adhesive rectangle aperture 12cm x 24cm

Aperture Drapes with Adhesive

RE-ORDER	DESCRIPTION	CARTON QTY	NON STERILE
35-142	<b>Impervious Drape with Adhesive Aperture</b>	30	35-142NS

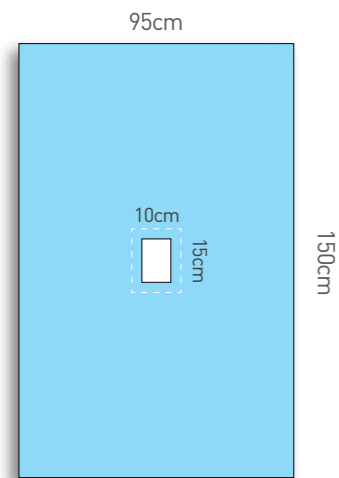

- Drape 95cm x 150cm
- Adhesive aperture 10cm x 15cm

Aperture Drapes with Adhesive

RE-ORDER	DESCRIPTION	CARTON QTY	NON STERILE
35-140	<b>Impervious Drape with Adhesive Oval Aperture</b>	50	35-140NS

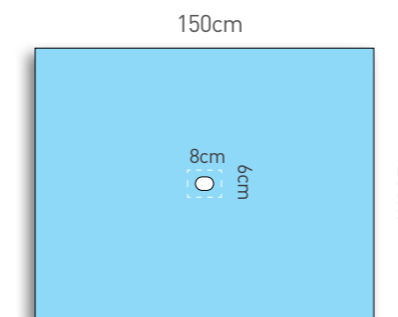

- Drape 150cm x 120cm
- Adhesive oval aperture 8cm x 6cm

Aperture Drapes with Adhesive

RE-ORDER	DESCRIPTION	CARTON QTY	NON STERILE
28-340	<b>Fluid Resistant CVC Drape with Adhesive Square Aperture</b>	60	ST 0297

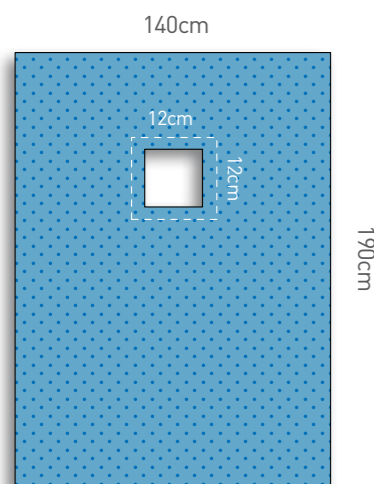

- Drape 140cm x 190cm
- Adhesive square aperture 12cm x 12cm

Aperture Drapes with Adhesive

RE-ORDER	DESCRIPTION	CARTON QTY	NON STERILE
35-087	<b>Impervious CVC Drape with Tear Line</b>	20	35-087NS

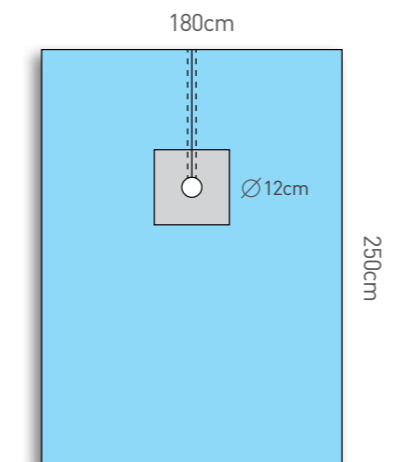

- CVC drape 180cm x 250cm with tear line
- Round aperture 12cm diameter with adhesive
- Clear PE 45cm x 45cm



 Protex® Drapes have an absorbent top layer with an impervious backing.

PRODUCT MATERIAL KEY:



Aperture Drapes with Adhesive

RE-ORDER	DESCRIPTION	CARTON QTY	NON STERILE
35-117	<b>CVC Drape with Adhesive Split Aperture</b>	30	35-117NS

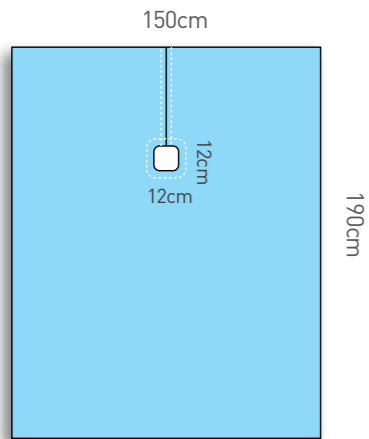

- Drape 150cm x 190cm
- Aperture adhesive 12cm x 12cm
- Tear line for easy drape removal

Aperture Drapes with Reinforcement and Adhesive

RE-ORDER	DESCRIPTION	CARTON QTY	NON STERILE
35-143	<b>Impervious Medical Imaging Drape with Adhesive Rectangle Aperture</b>	50	35-143NS

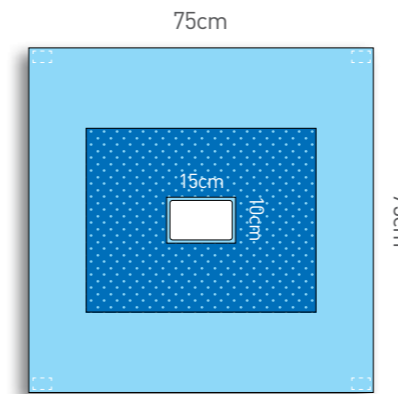

- Drape 75cm x 75cm
- Ultra reinforcement 50cm x 40cm
- Adhesive aperture 15cm x 10cm
- Adhesive corner tabs

Aperture Drapes with Adhesive

RE-ORDER	DESCRIPTION	CARTON QTY	NON STERILE
35-052	<b>Impervious PICC Drape with Clear Rectangle Aperture</b>	12	35-052NS

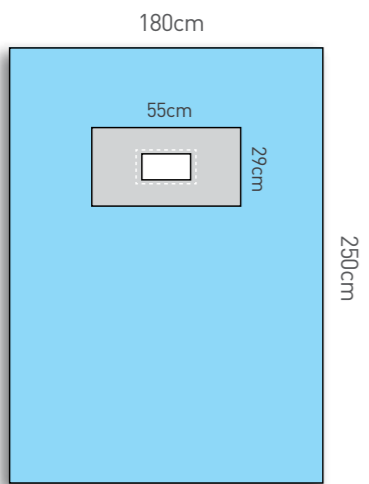

- Drape 180cm x 250cm
- Clear rectangle aperture 15cm x 8cm with adhesive
- Clear PE 55cm x 29cm

Aperture Drapes with Reinforcement and Adhesive

RE-ORDER	DESCRIPTION	CARTON QTY	NON STERILE
35-024	<b>Impervious Medical Imaging Drape with Adhesive Square Aperture</b>	20	35-024NS

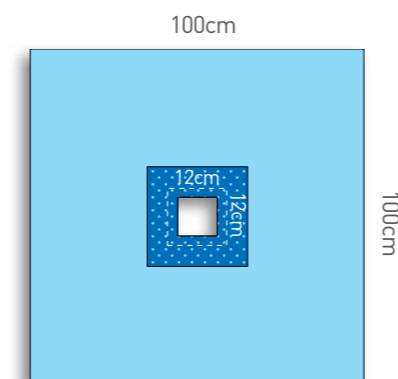

- Drape 100cm x 100cm
- Ultra reinforcement 30cm x 30cm
- Adhesive square aperture 12cm x 12cm

Aperture Drapes with Adhesive

RE-ORDER	DESCRIPTION	CARTON QTY	NON STERILE
35-058A	<b>CVL Insertion Drape</b>	26	35-058NS

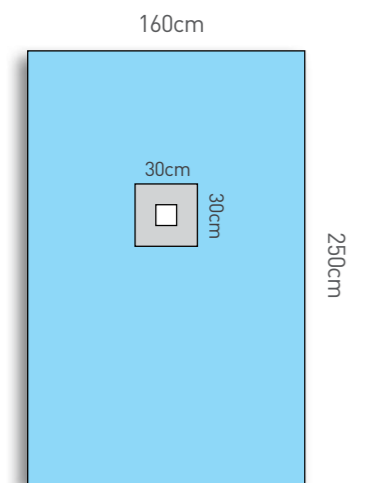

- Drape 160cm x 250cm
- Adhesive aperture 10cm x 10cm
- Clear PE 30cm x 30cm

Aperture Drapes with Reinforcement and Adhesive

RE-ORDER	DESCRIPTION	CARTON QTY	NON STERILE
35-063	<b>Impervious Medical Imaging Drape with Adhesive Square Aperture</b>	20	35-063NS

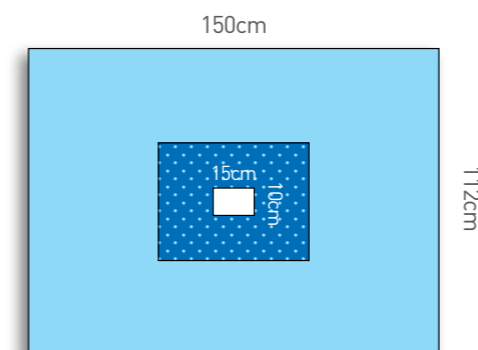

- Drape 150cm x 112cm
- Ultra reinforcement 55cm x 43cm
- Adhesive rectangle aperture 15cm x 10cm

 Protex® Drapes have an absorbent top layer with an impervious backing.

PRODUCT MATERIAL KEY:



Aperture Drapes with Reinforcement and Adhesive

RE-ORDER	DESCRIPTION	CARTON QTY	NON STERILE
----------	-------------	------------	-------------

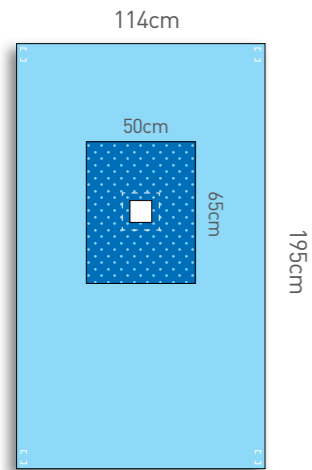

RE-ORDER	DESCRIPTION	CARTON QTY	NON STERILE
35-132	<b>Impervious Medical Imaging Drape with Adhesive Square Aperture</b> • Drape 114cm x 195cm • Ultra reinforcement 50cm x 65cm • Adhesive aperture 10cm x 10cm • Adhesive corner tabs	40	35-132NS

Aperture Drapes with Reinforcement and Adhesive

RE-ORDER	DESCRIPTION	CARTON QTY	NON STERILE
----------	-------------	------------	-------------

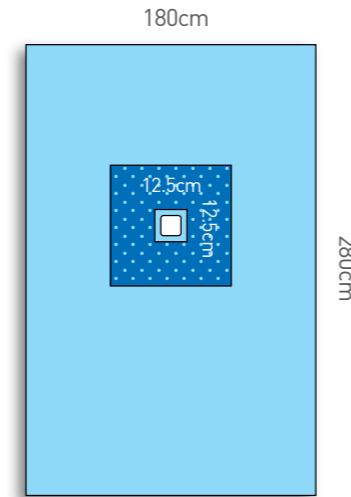

RE-ORDER	DESCRIPTION	CARTON QTY	NON STERILE
35-149	<b>CVC Drape Adhesive Aperture</b> • Drape 180cm x 280cm • Ultra reinforcement 75cm x 75cm • Adhesive square aperture 12.5cm x 12.5cm	16	35-149NS

Aperture Drapes with Reinforcement and Adhesive

RE-ORDER	DESCRIPTION	CARTON QTY	NON STERILE
----------	-------------	------------	-------------

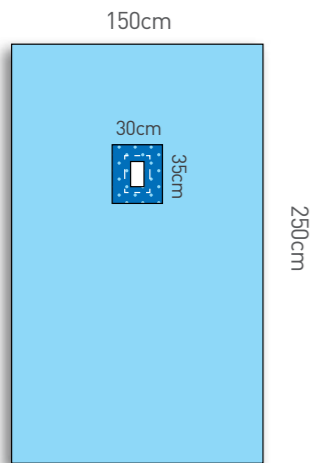

RE-ORDER	DESCRIPTION	CARTON QTY	NON STERILE
35-144	<b>Impervious Drape with Adhesive Rectangle Aperture</b> • Drape 150cm x 250cm • Ultra reinforcement 30cm x 35cm • Adhesive rectangle aperture 8cm x 15cm	24	35-144NS

Aperture Drapes with Reinforcement and Adhesive

RE-ORDER	DESCRIPTION	CARTON QTY	NON STERILE
----------	-------------	------------	-------------

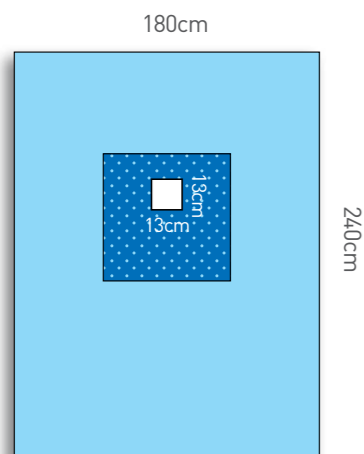

RE-ORDER	DESCRIPTION	CARTON QTY	NON STERILE
35-076	<b>CVC Drape</b> • Drape 180cm x 240cm • Ultra reinforcement 75cm x 75cm • Adhesive aperture 13cm x 13cm	20	35-076NS

 Protex® Drapes have an absorbent top layer with an impervious backing.

PRODUCT MATERIAL KEY:



Split Drapes

RE-ORDER	DESCRIPTION	CARTON QTY	NON STERILE
----------	-------------	------------	-------------

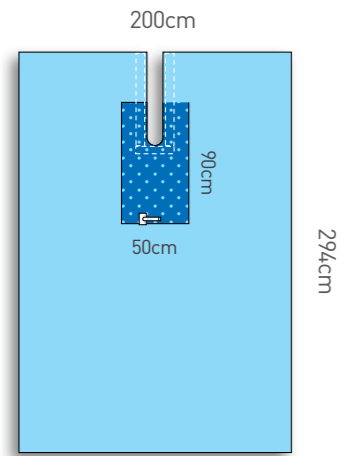

35-017	<b>Drape with Adhesive U-Split</b>	10	35-017NS
	<ul style="list-style-type: none"> <li>• Drape 200cm x 294cm</li> <li>• Ultra reinforcement 50cm x 90cm</li> <li>• Adhesive U-Split 11.5cm x 69cm</li> <li>• Tube holder fastener</li> </ul>		

Split Drapes

RE-ORDER	DESCRIPTION	CARTON QTY	NON STERILE
----------	-------------	------------	-------------

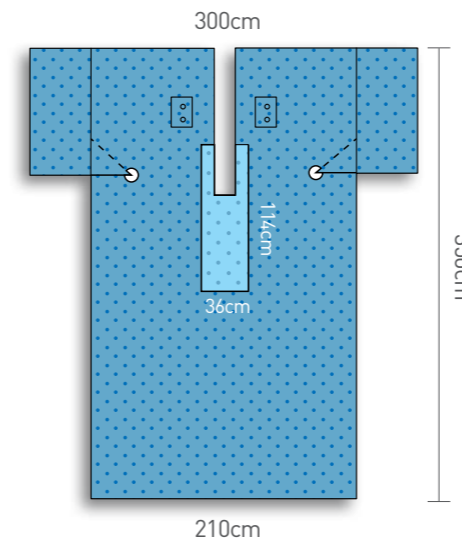

28-382	<b>Orthopaedic Split T-Drape</b>	10	ST 0081
	<ul style="list-style-type: none"> <li>• Drape 300(210)cm x 350cm</li> <li>• Split 10cm x 117cm</li> <li>• Reinforcement 36cm x 114cm</li> <li>• Cord/Tube holders</li> </ul>		

Split Drapes

RE-ORDER	DESCRIPTION	CARTON QTY	NON STERILE
----------	-------------	------------	-------------

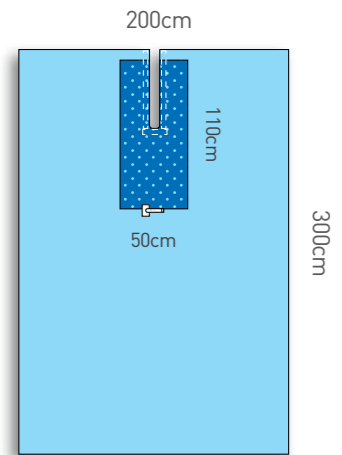

35-016	<b>Drape with Adhesive Split</b>	12	35-016NS
	<ul style="list-style-type: none"> <li>• Drape 200cm x 300cm</li> <li>• Ultra reinforcement 50cm x 110cm</li> <li>• Adhesive U-Split 7.5cm x 58cm</li> <li>• Tube holder fastener</li> </ul>		

Split Drapes

RE-ORDER	DESCRIPTION	CARTON QTY	NON STERILE
----------	-------------	------------	-------------

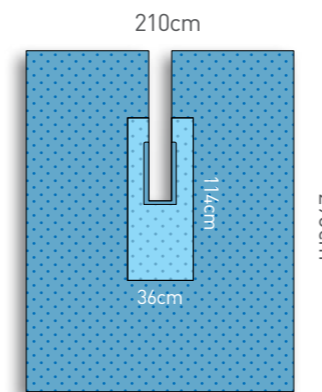

28-555	<b>Orthopaedic Split Drape</b>	11	ST 0018
	<ul style="list-style-type: none"> <li>• Drape 210cm x 290cm</li> <li>• Split 10cm x 117cm</li> <li>• Reinforcement 36cm x 114cm</li> </ul>		

Split Drapes

RE-ORDER	DESCRIPTION	CARTON QTY	NON STERILE
----------	-------------	------------	-------------

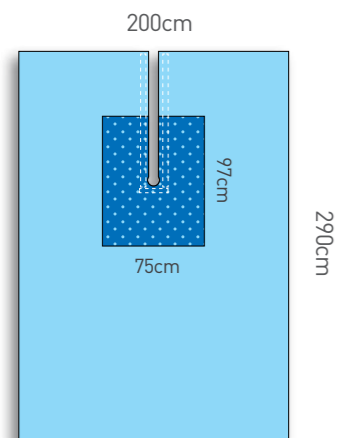

35-025	<b>Drape with Adhesive Keyhole Split</b>	6	35-025NS
	<ul style="list-style-type: none"> <li>• Drape 200cm x 290cm</li> <li>• Ultra reinforcement 75cm x 97cm</li> <li>• Adhesive keyhole split 7cm x 100cm</li> </ul>		

Split Drape Sets

RE-ORDER	DESCRIPTION	CARTON QTY	NON STERILE
----------	-------------	------------	-------------

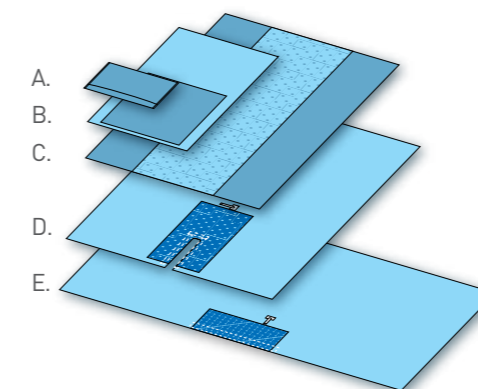

40-755	<b>U-Drape Pack</b>	6	
A.	1 x Suture bag with tape 39cm x 29cm		DP 3000
B.	1 x Mayo cover (Medium) 58.5cm x 114cm		PE 0001
C.	1 x Back table cover (Medium) 137cm x 230cm		PE0003/B
D.	1 x Drape 200 x 300cm with split 7.5 x 58cm		35-016NS
E.	1 x Drape universal top with armboard cover 260cm x 150cm		35-029NS

 Protex® Drapes have an absorbent top layer with an impervious backing.

PRODUCT MATERIAL KEY:



Back Table Covers

RE-ORDER	DESCRIPTION	CARTON QTY	NON STERILE
----------	-------------	------------	-------------

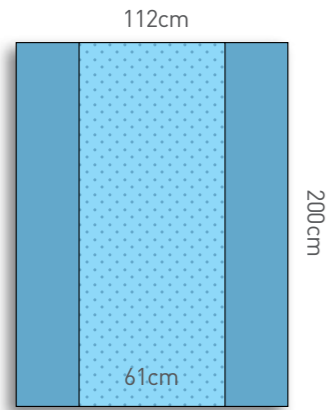

28-617	<b>Small Back Table Cover Reinforced</b> • Back table cover 112cm x 200cm • Reinforcement 61cm x 200cm	40	PE 0004
--------	--	----	---------

Back Table Covers

RE-ORDER	DESCRIPTION	CARTON QTY	NON STERILE
----------	-------------	------------	-------------

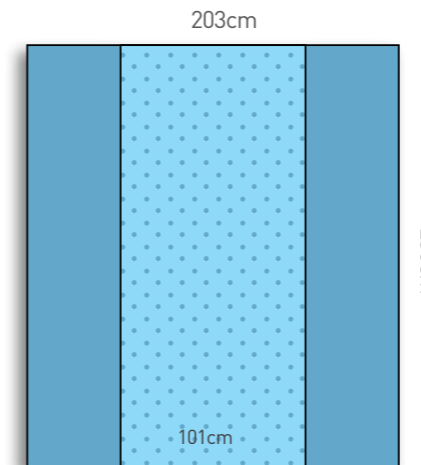

28-612	<b>Large Back Table Cover Reinforced</b> • Back table cover 203cm x 230cm • Reinforcement 101cm x 230cm	22	PE 0005
--------	---	----	---------

Back Table Covers

RE-ORDER	DESCRIPTION	CARTON QTY	NON STERILE
----------	-------------	------------	-------------

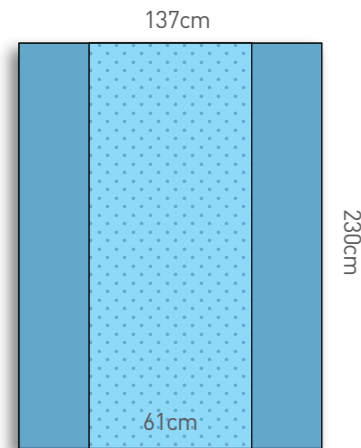

28-616	<b>Medium Back Table Cover Reinforced</b> • Back table cover 137cm x 230cm • Reinforcement 61cm x 230cm	38	PE 0003
--------	---	----	---------

Back Table Covers

RE-ORDER	DESCRIPTION	CARTON QTY	NON STERILE
----------	-------------	------------	-------------

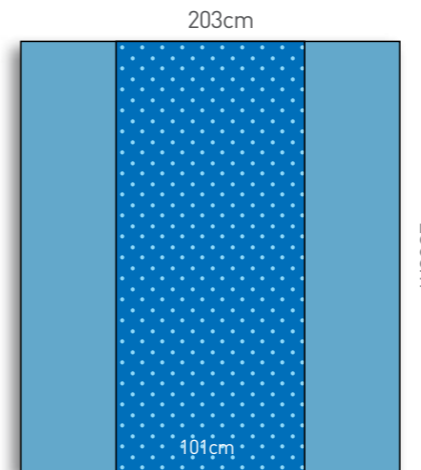

28-368	<b>Large Heavy Duty Back Table Cover Reinforced</b> • Back table cover 203cm x 230cm • Reinforcement 101cm x 230cm	20	PE 0105
--------	--	----	---------

Back Table Covers

RE-ORDER	DESCRIPTION	CARTON QTY	NON STERILE
----------	-------------	------------	-------------

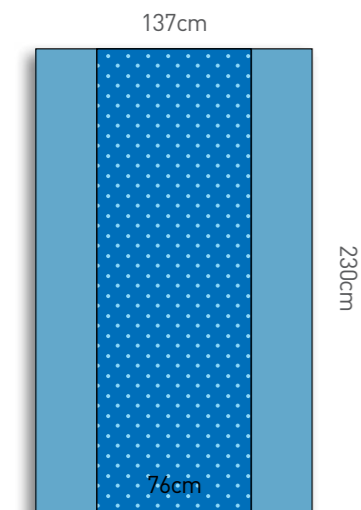

28-606	<b>Medium Heavy Duty Back Table Cover Reinforced</b> • Back table cover 137cm x 230cm • Reinforcement 76cm x 230cm	20	PE 0103
--------	--	----	---------

 Protex® Drapes have an absorbent top layer with an impervious backing.

PRODUCT MATERIAL KEY:



Mayo Covers

RE-ORDER	DESCRIPTION	CARTON QTY	NON STERILE
----------	-------------	------------	-------------

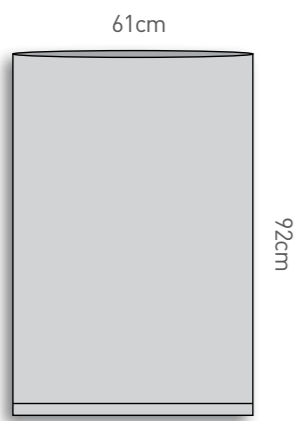

22-212	<b>Mayo Cover</b> • 61cm x 92cm Clear plastic	100	DP 1624
--------	---	-----	---------

Mayo Covers

RE-ORDER	DESCRIPTION	CARTON QTY	NON STERILE
----------	-------------	------------	-------------

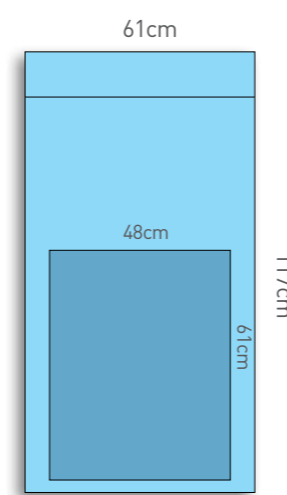

28-380	<b>Medium Mayo Cover - Double Wrap</b> • Drape 61cm x 117cm • Reinforcement 48cm x 61cm	30	PE 0001
--------	---	----	---------

Mayo Covers

RE-ORDER	DESCRIPTION	CARTON QTY	NON STERILE
----------	-------------	------------	-------------

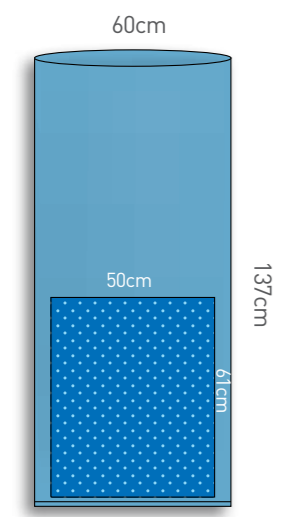

35-006	<b>Mayo Cover Ultra</b> • Drape 60cm x 137cm • Ultra reinforcement 50cm x 61cm	30	35-006NS
--------	--	----	----------

Mayo Covers

RE-ORDER	DESCRIPTION	CARTON QTY	NON STERILE
----------	-------------	------------	-------------

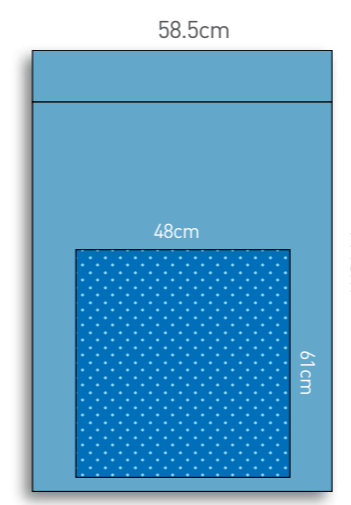

28-377	<b>Medium Heavy Duty Mayo Cover - Double Wrap</b> • Drape 58.5cm x 114cm • Reinforcement 48cm x 61cm	30	PE 0101
--------	--	----	---------

Mayo Covers

RE-ORDER	DESCRIPTION	CARTON QTY	NON STERILE
----------	-------------	------------	-------------

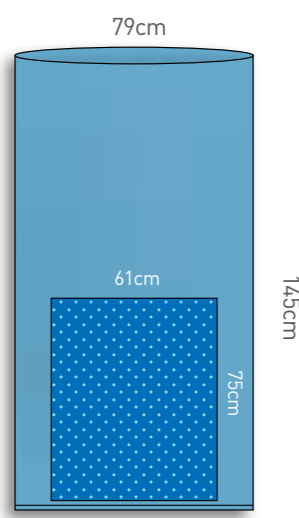

35-007	<b>Mayo Cover Ultra</b> • Drape 79cm x 145cm • Ultra reinforcement 61cm x 75cm	25	35-007NS
--------	--	----	----------

Mayo Covers

RE-ORDER	DESCRIPTION	CARTON QTY	NON STERILE
----------	-------------	------------	-------------

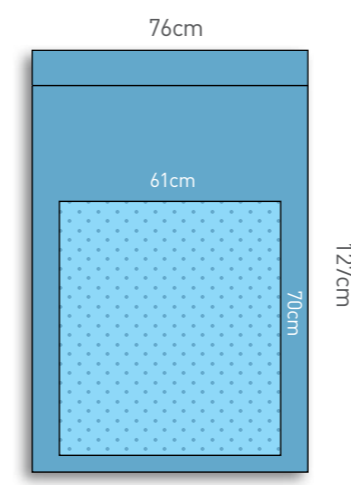

28-501	<b>Large Mayo Cover - Double Wrap</b> • Drape 76cm x 127cm • Reinforcement 61cm x 70cm	25	PE 0006
--------	--	----	---------

 Protex® Drapes have an absorbent top layer with an impervious backing.

**Mayo Covers**

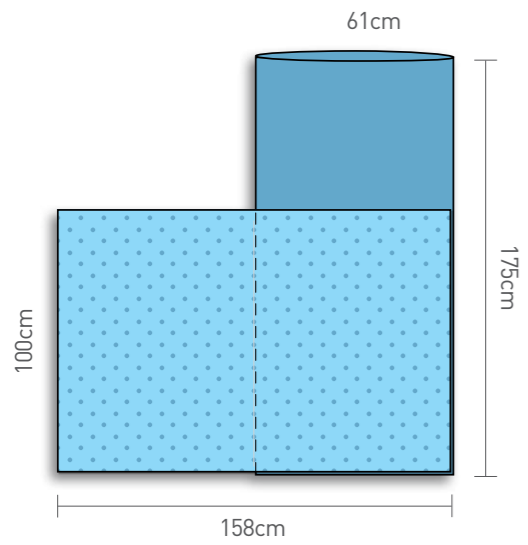

RE-ORDER	DESCRIPTION	CARTON QTY	NON STERILE
35-037	<b>Mayo Cover - Cardiac</b> • Drape 79cm x 175cm • Reinforcement 158cm x 100cm	25	35-037NS

**PRODUCT MATERIAL KEY:**



**Stockinette and Leggings**

RE-ORDER	DESCRIPTION	CARTON QTY	NON STERILE
28-200	<b>Bariatric Leggings Double Large</b> • 87cm x 96cm (Pair)	36	ST 0228

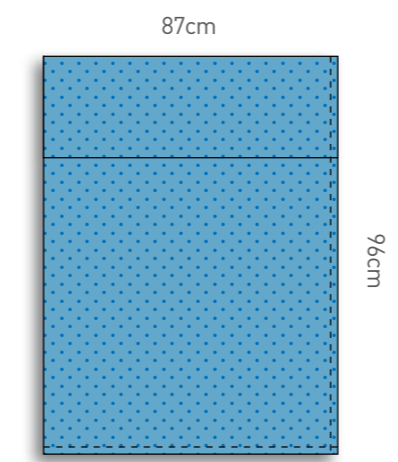

**Stockinette and Leggings**

RE-ORDER	DESCRIPTION	CARTON QTY	NON STERILE
28-201	<b>Medium Impervious Stockinette</b> • 97cm x 20cm	30	PE 0011

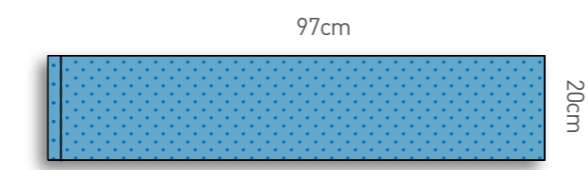

**Stockinette and Leggings**

RE-ORDER	DESCRIPTION	CARTON QTY	NON STERILE
28-202	<b>Large Impervious Stockinette</b> • 122cm x 30cm	20	PE 0009

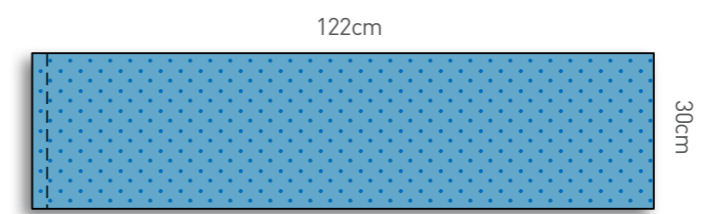

 Protex® Drapes have an absorbent top layer with an impervious backing.

PRODUCT MATERIAL KEY:



Drape Accessories	RE-ORDER	DESCRIPTION	CARTON QTY	NON STERILE
	28-500	<b>Drape Tape</b> • 55cm x 10cm	200	ST 0028

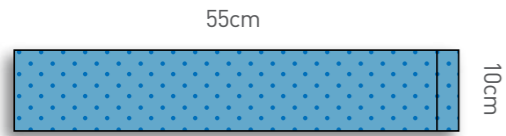

Drape Accessories	RE-ORDER	DESCRIPTION	CARTON QTY	NON STERILE
	35-002	<b>Instrument Pouch</b> • Pouch 18cm x 30cm • Dual instrument pouches • Adhesive backing	40	35-002NS

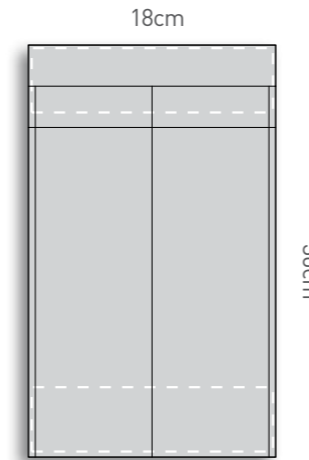

Drape Accessories	RE-ORDER	DESCRIPTION	CARTON QTY	NON STERILE
	35-094	<b>Tube Holder Fastener</b> • 2.5cm x 12.5cm • X-Ray detectable • Adhesive backing	200	DP 0790



Drape Accessories	RE-ORDER	DESCRIPTION	CARTON QTY	NON STERILE
	35-003	<b>Instrument Pouch</b> • Pouch 24.5cm x 47cm • 3 instrument pouches • Adhesive backing	40	35-003NS

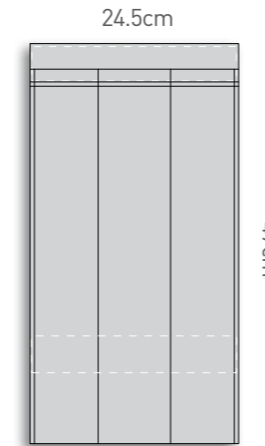

Drape Accessories	RE-ORDER	DESCRIPTION	CARTON QTY	NON STERILE
	35-068	<b>Saddle Bag</b> • 97cm x 28cm • Fabric fastener strips for adjustable lengths	40	35-068NS

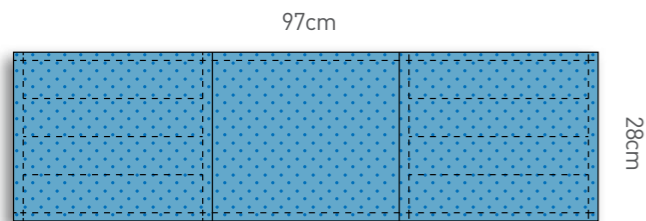

Drape Accessories	RE-ORDER	DESCRIPTION	CARTON QTY	NON STERILE
	22-209	<b>Light Handle Cover with Foam Disc</b> • Cover	150	DP 0425

 Protex® Drapes have an absorbent top layer with an impervious backing.

PRODUCT MATERIAL KEY:

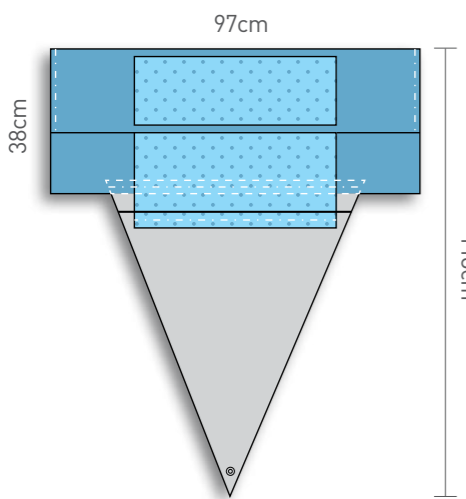

Fluid Pouches	RE-ORDER	DESCRIPTION	CARTON QTY	NON STERILE
	28-571	<b>Under Buttocks Drape with Pouch</b> <ul style="list-style-type: none"> <li>• Drape 97cm x 38cm</li> <li>• Pouch 68cm x 77cm</li> <li>• Reinforcements 53cm x 18cm, 53cm x 25cm</li> </ul>	20	PE 0017

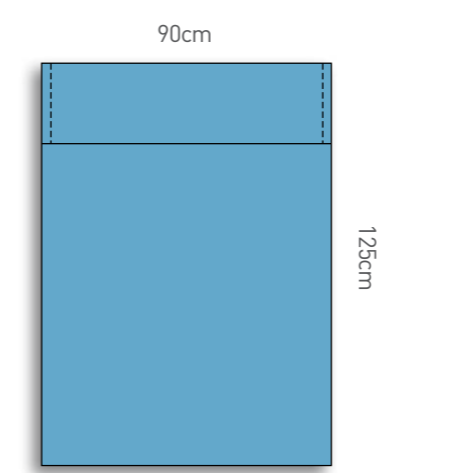
Fluid Pouches	RE-ORDER	DESCRIPTION	CARTON QTY	NON STERILE
	35-109	<b>Under Buttocks Drape</b> <ul style="list-style-type: none"> <li>• Drape 90cm x 125cm</li> <li>• Cuff for sterile application</li> <li>• Impervious poly material</li> </ul>	25	35-109NS

Fluid Pouches	RE-ORDER	DESCRIPTION	CARTON QTY	NON STERILE
	28-572	<b>V-Collection Pouch with Adhesive</b> <ul style="list-style-type: none"> <li>• Pouch 68cm x 89cm</li> <li>• Reinforcement 53cm x 18cm</li> <li>• Adhesive backing</li> </ul>	50	PE 0018

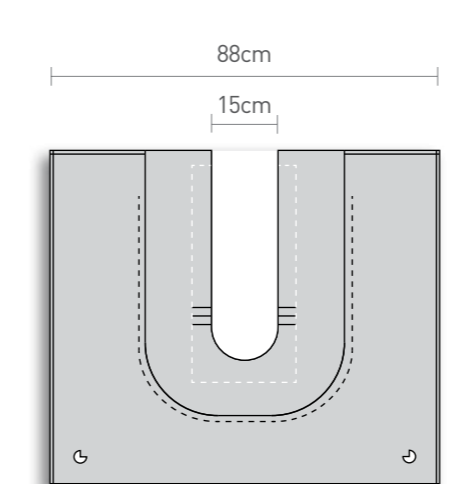
Fluid Pouches	RE-ORDER	DESCRIPTION	CARTON QTY	NON STERILE
	35-078	<b>Fluid Collection Pouch Drape</b> <ul style="list-style-type: none"> <li>• Drape 88cm x 76cm</li> <li>• Adhesive split 15cm x 47cm</li> <li>• Suction ports x2</li> </ul>	40	35-078NS

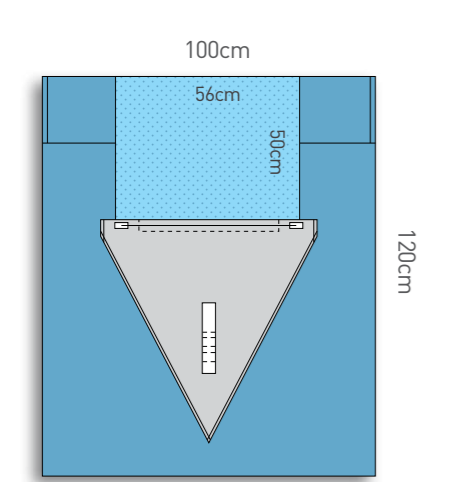
Fluid Pouches	RE-ORDER	DESCRIPTION	CARTON QTY	NON STERILE
	35-099	<b>Under Buttocks Drape with Pouch</b> <ul style="list-style-type: none"> <li>• Drape 100cm x 120cm</li> <li>• Fluid collection pouch 65cm x 67cm</li> <li>• Cuff for sterile application</li> <li>• Ultra reinforcement 56cm x 50cm</li> <li>• Fluid measurement guide</li> </ul>	30	35-099NS





 Protex® Drapes have an absorbent top layer with an impervious backing.

PRODUCT MATERIAL KEY:

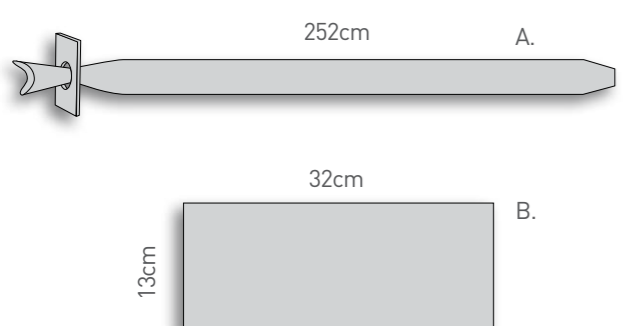

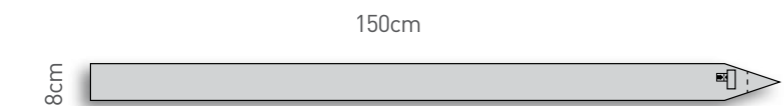
Probe Covers	RE-ORDER	DESCRIPTION	CARTON QTY	NON STERILE
	35-038	<b>Transducer Cover Set</b> <ul style="list-style-type: none"> <li>• Cover 150cm x 8cm</li> <li>• Perforated tip</li> <li>• Adhesive securing tab</li> <li>• Clear PE material</li> </ul> <p>A.</p> <ul style="list-style-type: none"> <li>• Transducer cover bag 252cm x 15cm</li> <li>• Clear PE material</li> <li>• Probe fastener</li> </ul> <p>B.</p> <ul style="list-style-type: none"> <li>• Transducer cover bag 32cm x 13cm</li> <li>• Soft, clear PE material</li> </ul>	50	35-038NS

Probe Covers	RE-ORDER	DESCRIPTION	CARTON QTY	NON STERILE
	35-093	<b>Dental Drill Cover</b> <ul style="list-style-type: none"> <li>• Cover 150cm x 8cm</li> <li>• Perforated tip</li> <li>• Adhesive securing tab</li> <li>• Clear PE material</li> </ul>	50	35-093NS

Probe Covers	RE-ORDER	DESCRIPTION	CARTON QTY	NON STERILE
	35-082	<b>Ultrasound Probe Cover</b> <ul style="list-style-type: none"> <li>• Cover 15cm x 150cm</li> <li>• Probe fastener</li> <li>• Clear PE material</li> </ul>	50	35-082NS

II Covers	RE-ORDER	DESCRIPTION	CARTON QTY	NON STERILE
	35-079	<b>II Cover</b> <ul style="list-style-type: none"> <li>• 30(80)cm x 30cm</li> <li>• Elastic diameter relaxed: 30cm</li> <li>• Elastic diameter stretched: 80cm</li> </ul>	80	35-079NS

II Covers	RE-ORDER	DESCRIPTION	CARTON QTY	NON STERILE
	29-713	<b>II Cover</b> <ul style="list-style-type: none"> <li>• 45(118)cm x 40cm</li> <li>• Elastic diameter relaxed: 45cm</li> <li>• Elastic diameter stretched: 118cm</li> </ul>	60	DP 1217

II Covers	RE-ORDER	DESCRIPTION	CARTON QTY	NON STERILE
	29-716	<b>II Cover</b> <ul style="list-style-type: none"> <li>• 67(145)cm x 70cm</li> <li>• Elastic diameter relaxed: 67cm</li> <li>• Elastic diameter stretched: 145cm</li> </ul>	50	DP 2802

 Protex® Drapes have an absorbent top layer with an impervious backing.

PRODUCT MATERIAL KEY:



**II Covers** RE-ORDER DESCRIPTION CARTON QTY NON STERILE

35-711	<b>II Cover</b> • 76(214)cm x 105cm • Elastic diameter relaxed: 76cm • Elastic diameter stretched: 214cm	30	DP 1212
--------	---	----	---------

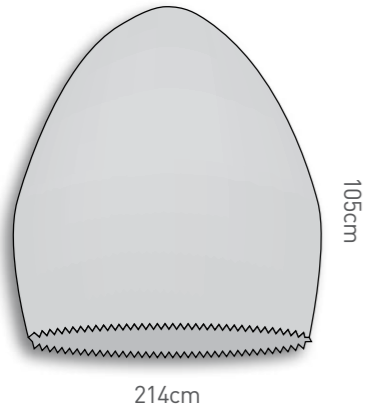

**Leadscreen Covers** RE-ORDER DESCRIPTION CARTON QTY NON STERILE

29-730	<b>Leadscreen Cover</b> • 19(57.5)cm x 60cm • Elastic opening	100	DP 1214
--------	---	-----	---------

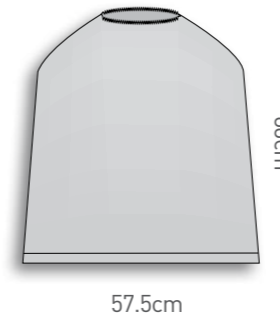

**II Covers** RE-ORDER DESCRIPTION CARTON QTY NON STERILE

29-710	<b>II Cover</b> • 91(232)cm x 115cm • Elastic diameter relaxed: 91cm • Elastic diameter stretched: 232cm	30	DP 1211
--------	---	----	---------

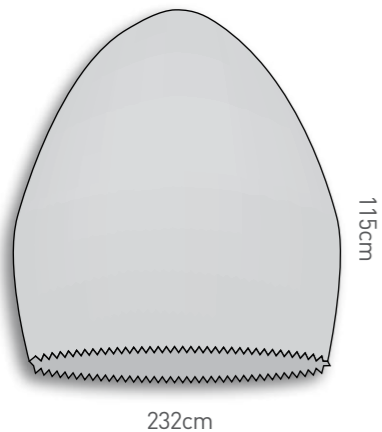

**Leadscreen Covers** RE-ORDER DESCRIPTION CARTON QTY NON STERILE

29-731	<b>Leadscreen Cover</b> • 25(80)cm x 80cm • Elastic opening	50	DP 1215
--------	---	----	---------

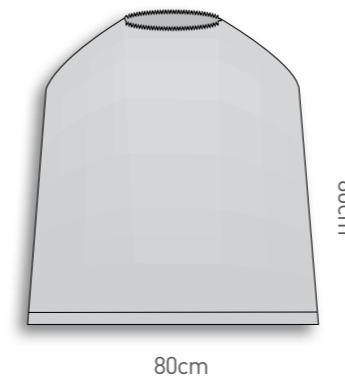

**II Covers** RE-ORDER DESCRIPTION CARTON QTY NON STERILE

29-712	<b>II Cover</b> • 120(282)cm x 140cm • Elastic diameter relaxed: 120cm • Elastic diameter stretched: 282cm	20	DP 1213
--------	---	----	---------

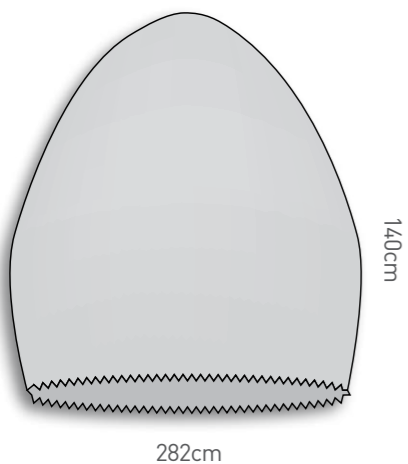

**Leadscreen Covers** RE-ORDER DESCRIPTION CARTON QTY NON STERILE

29-738	<b>Leadscreen Cover</b> • 40(104)cm x 105cm • Elastic opening	50	DP 2805
--------	---	----	---------

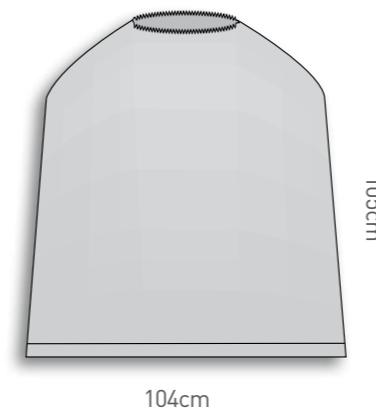

 Protex® Drapes have an absorbent top layer with an impervious backing.

PRODUCT MATERIAL KEY:



Leadscreen Covers

RE-ORDER	DESCRIPTION	CARTON QTY	NON STERILE
29-732	<b>Leadscreen Cover</b> • 50(130)cm x 90cm • Elastic opening	60	DP 1218

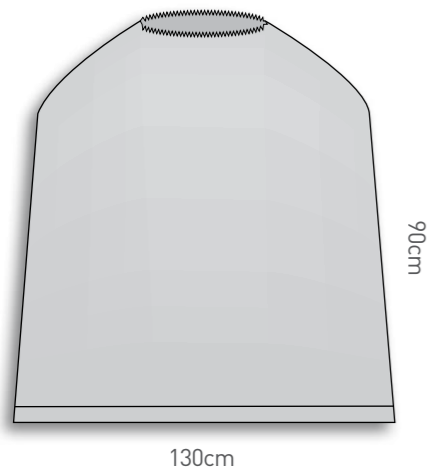

Leadscreen Covers

RE-ORDER	DESCRIPTION	CARTON QTY	NON STERILE
35-075	<b>Leadscreen Cover with Split</b> • 105cm x 105cm • Adhesive tab	50	35-075NS

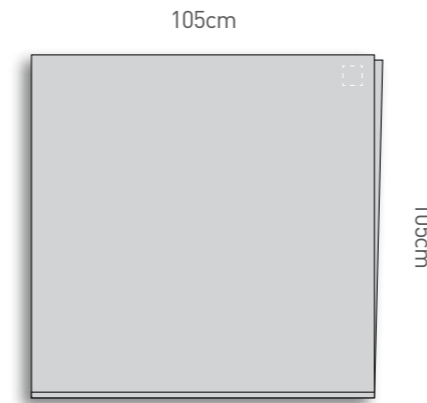

Leadscreen Covers

RE-ORDER	DESCRIPTION	CARTON QTY	NON STERILE
29-733	<b>Leadscreen Cover with Adhesive</b> • 33(91)cm x 75cm • Adhesive tabs • Elastic opening	60	DP 1891

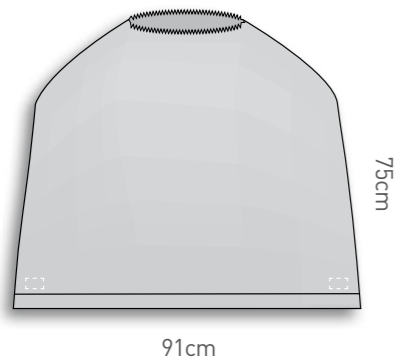

Leadscreen Covers

RE-ORDER	DESCRIPTION	CARTON QTY	NON STERILE
29-737	<b>Leadscreen Cover</b> • Drape 60 x 60cm with cuff • Fastening arm with adhesive securing tape	100	DP 2804

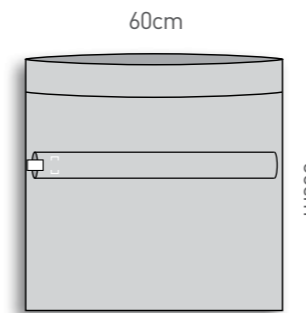

Leadscreen Covers

RE-ORDER	DESCRIPTION	CARTON QTY	NON STERILE
35-080	<b>Leadscreen Cover with Adhesive</b> • 25(116)cm x 90cm • Adhesive tabs • Elastic opening	50	35-080NS

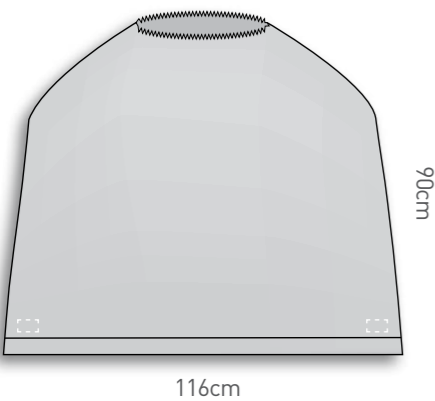

Leadscreen Covers

RE-ORDER	DESCRIPTION	CARTON QTY	NON STERILE
29-736	<b>Leadscreen Cover with Adhesive</b> • Drape 105cm x 130cm (cuff closed) • Drape 105cm x 148cm (cuff extended) • 2 x Fastening arms with adhesive securing tape	50	DP 2803

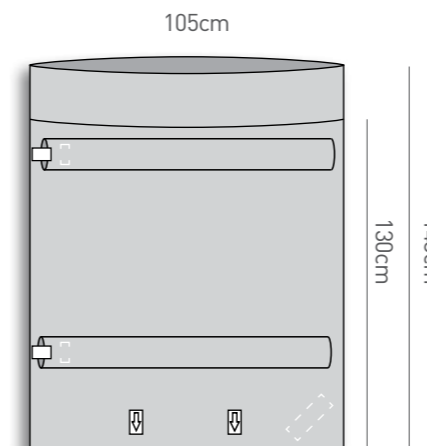

Empowering  
performance  
since 1986

**Multigate Medical Products**

27 Llewellyn Avenue

Villawood NSW 2163

Australia

T +61 (0)2 8718 2888

F +61 (0)2 8718 2889

[enquiries@multigate.com.au](mailto:enquiries@multigate.com.au)

[www.multigate.com.au](http://www.multigate.com.au)

For more information please contact your  
local Business Development Manager:

**(02) 8718 2888** or visit [multigate.com.au](http://multigate.com.au)